



FFT MegaCore Function

User Guide



101 Innovation Drive
San Jose, CA 95134
www.altera.com

UG-FFT-11.1



Subscribe

©2011 Altera Corporation. All rights reserved. ALTERA, ARRIA, CYCLONE, HARDCOPY, MAX, MEGACORE, NIOS, QUARTUS and STRATIX words and logos are trademarks of Altera Corporation and registered in the U.S. Patent and Trademark Office and in other countries. All other words and logos identified as trademarks or service marks are the property of their respective holders as described at www.altera.com/common/legal.html. Altera warrants performance of its semiconductor products to current specifications in accordance with Altera's standard warranty, but reserves the right to make changes to any products and services at any time without notice. Altera assumes no responsibility or liability arising out of the application or use of any information, product, or service described herein except as expressly agreed to in writing by Altera. Altera customers are advised to obtain the latest version of device specifications before relying on any published information and before placing orders for products or services.



Chapter 1. About This MegaCore Function

Release Information	1-1
Device Family Support	1-1
Features	1-2
General Description	1-3
Fixed Transform Size Architecture	1-3
Variable Streaming Architecture	1-4
MegaCore Verification	1-4
Performance and Resource Utilization	1-4
Cyclone III Devices	1-5
Stratix III Devices	1-8
Stratix IV Devices	1-11
Stratix V Devices	1-14
Installation and Licensing	1-18
OpenCore Plus Evaluation	1-18
OpenCore Plus Time-Out Behavior	1-19

Chapter 2. Getting Started

Design Flows	2-1
DSP Builder Flow	2-1
MegaWizard Plug-In Manager Flow	2-2
Parameterize the MegaCore Function	2-3
Set Up Simulation	2-10
Generate the MegaCore Function	2-10
Simulate the Design	2-12
Simulate in the MATLAB Software	2-13
Fixed Transform Architectures	2-13
Variable Streaming Architecture	2-14
Simulate with IP Functional Simulation Models	2-15
Simulating in Third-Party Simulation Tools Using NativeLink	2-15
Compile the Design	2-16
Fixed Transform Architecture	2-16
Variable Streaming Architecture	2-16
Program a Device	2-16

Chapter 3. Functional Description

Buffered, Burst, & Streaming Architectures	3-1
Variable Streaming Architecture	3-2
The Avalon Streaming Interface	3-3
FFT Processor Engine Architectures	3-4
Radix-2 ² Single Delay Feedback Architecture	3-4
Mixed Radix-4/2 Architecture	3-5
Quad-Output FFT Engine Architecture	3-5
Single-Output FFT Engine Architecture	3-6
I/O Data Flow Architectures	3-6
Streaming	3-7
Streaming FFT Operation	3-7
Enabling the Streaming FFT	3-8

Variable Streaming	3-8
Change the Block Size	3-8
Enabling the Variable Streaming FFT	3-9
Dynamically Changing the FFT Size	3-10
The Effect of I/O Order	3-10
Buffered Burst	3-11
Burst	3-13
Parameters	3-14
Signals	3-16
Appendix 4. Block Floating Point Scaling	
Introduction	4-1
Block Floating Point	4-1
Calculating Possible Exponent Values	4-2
Implementing Scaling	4-2
Achieving Unity Gain in an IFFT+FFT Pair	4-4
Additional Information	
Revision History	Info-1
How to Contact Altera	Info-2
Typographic Conventions	Info-2

Release Information

Table 1–1 lists information about this release of the Altera® FFT MegaCore® function.

Table 1–1. FFT MegaCore Function Release Information

Item	Description
Version	11.1
Release Date	November 2011
Ordering Code	IP-FFT
Product ID	0034
Vendor ID	6AF7

 For more information about this release, refer to the [MegaCore IP Library Release Notes and Errata](#).

Altera verifies that the current version of the Quartus® II software compiles the previous version of each MegaCore® function. The [MegaCore IP Library Release Notes and Errata](#) report any exceptions to this verification. Altera does not verify compilation with MegaCore function versions older than one release.

Device Family Support

Table 1–2 lists the device support levels for Altera IP cores.

Table 1–2. Altera IP Core Device Support Levels

FPGA Device Families	HardCopy Device Families
Preliminary support —The IP core is verified with preliminary timing models for this device family. The IP core meets all functional requirements, but might still be undergoing timing analysis for the device family. It can be used in production designs with caution.	HardCopy Companion —The IP core is verified with preliminary timing models for the HardCopy companion device. The IP core meets all functional requirements, but might still be undergoing timing analysis for the HardCopy device family. It can be used in production designs with caution.
Final support —The IP core is verified with final timing models for this device family. The IP core meets all functional and timing requirements for the device family and can be used in production designs.	HardCopy Compilation —The IP core is verified with final timing models for the HardCopy device family. The IP core meets all functional and timing requirements for the device family and can be used in production designs.

Table 1-3 lists the level of support offered by the FFT MegaCore function to each of the Altera device families.

Table 1-3. Device Family Support

Device Family	Support
Arria® GX	Final
Arria II GX	Final
Arria II GZ	Final
Arria V	Refer to the What's New in Altera IP page of the Altera website.
Cyclone®	Final
Cyclone II	Final
Cyclone III	Final
Cyclone III LS	Final
Cyclone IV	Final
Cyclone V	Refer to the What's New in Altera IP page of the Altera website.
HardCopy® II	HardCopy Compilation
HardCopy III	HardCopy Compilation
HardCopy IV E	HardCopy Compilation
HardCopy IV GX	HardCopy Compilation
Stratix®	Final
Stratix II	Final
Stratix II GX	Final
Stratix III	Final
Stratix IV GT	Final
Stratix IV GX/E	Final
Stratix V	Preliminary
Stratix GX	Final

Features

The following lists the features of the FFT MegaCore function:

- Bit-accurate MATLAB models
- Enhanced variable streaming FFT:
 - Single precision floating point or fixed point representation
 - Input and output orders include natural order, bit reversed or digit-reversed, and DC-centered ($-N/2$ to $N/2$)
 - Reduced memory requirements
 - Support for 8 to 32-bit data and twiddle width
- Radix-4, mixed radix-4/2 implementations (for floating point FFT), and radix-2² single delay feedback implementation (for fixed point FFT)

- Block floating-point architecture—maintains the maximum dynamic range of data during processing (not for variable streaming)
 - Uses embedded memory
 - Maximum system clock frequency more than 300 MHz
 - Optimized to use Stratix series DSP blocks and TriMatrix™ memory architecture
 - High throughput quad-output radix 4 FFT engine
 - Support for multiple single-output and quad-output engines in parallel
 - Multiple I/O data flow modes: streaming, buffered burst, and burst
- User control over optimization in DSP blocks or in speed in Stratix V devices, for streaming, buffered burst, and burst modes and for variable streaming fixed point mode
- Avalon® Streaming (Avalon-ST) compliant input and output interfaces
- Parameterization-specific VHDL and Verilog HDL testbench generation
- Transform direction (FFT/IFFT) specifiable on a per-block basis
- Easy-to-use IP Toolbench interface
- IP functional simulation models for use in Altera-supported VHDL and Verilog HDL simulators
- DSP Builder ready

 For more information about Avalon-ST interfaces, refer to the [Avalon Interface Specifications](#).

General Description

The FFT MegaCore function is a high performance, highly-parameterizable Fast Fourier transform (FFT) processor. The FFT MegaCore function implements a complex FFT or inverse FFT (IFFT) for high-performance applications.

The FFT MegaCore function implements the following architectures:

- Fixed transform size architecture
- Variable streaming architecture

Fixed Transform Size Architecture

The fixed transform architecture FFT implements a radix-2/4 decimation-in-frequency (DIF) FFT fixed-transform size algorithm for transform lengths of 2^m where $6 \leq m \leq 16$. This architecture uses block-floating point representations to achieve the best trade-off between maximum signal-to-noise ratio (SNR) and minimum size requirements.

The fixed transform architecture accepts as an input a two's complement format complex data vector of length N , where N is the desired transform length in natural order; the function outputs the transform-domain complex vector in natural order. An accumulated block exponent is output to indicate any data scaling that has occurred during the transform to maintain precision and maximize the internal signal-to-noise ratio. Transform direction is specifiable on a per-block basis via an input port.

Variable Streaming Architecture

The variable streaming architecture FFT implements two different types of architecture. The variable streaming FFT variations implement either a radix-2² single delay feedback architecture, using a fixed-point representation, or a mixed radix-4/2 architecture, using a single precision floating point representation. After you select your architecture type, you can configure your FFT variation during runtime to perform the FFT algorithm for transform lengths of 2^m where $3 \leq m \leq 18$.

The fixed-point representation grows the data widths naturally from input through to output thereby maintaining a high SNR at the output. The single precision floating point representation allows a large dynamic range of values to be represented while maintaining a high SNR at the output.

 For more information about radix-2² single delay feedback architecture, refer to *S. He and M. Torkelson, A New Approach to Pipeline FFT Processor, Department of Applied Electronics, Lund University, IPPS 1996.*

The order of the input data vector of size N can be natural, bit- or digit-reversed, or $-N/2$ to $N/2$ (DC-centered). The fixed-point representation supports a natural, bit-reversed, or DC-centered order and the floating point representation supports a natural, digit-reversed, or DC-centered order. The architecture outputs the transform-domain complex vector in natural, bit-reversed, or digit-reversed order. The transform direction is specifiable on a per-block basis using an input port.

MegaCore Verification

Before releasing a version of the FFT MegaCore function, Altera runs comprehensive regression tests to verify its quality and correctness.

Custom variations of the FFT MegaCore function are generated to exercise its various parameter options, and the resulting simulation models are thoroughly simulated with the results verified against master simulation models.

Performance and Resource Utilization

Performance varies depending on the FFT engine architecture and I/O data flow. All data represents the geometric mean of a three seed Quartus II synthesis sweep.

 Cyclone III devices use combinational look-up tables (LUTs) and logic registers; Stratix III devices use combinational adaptive look-up tables (ALUTs) and logic registers.

Cyclone III Devices

Table 1-4 lists the streaming data flow performance, using the 4 multipliers/2 adders complex multiplier structure, for width 16, for Cyclone III (EP3C10F256C6) devices.

Table 1-4. Performance with the Streaming Data Flow Engine Architecture—Cyclone III Devices

Points	Combinational LUTs	Logic Registers	Memory (Bits)	Memory (M9K)	9 × 9 Blocks	f _{MAX} (MHz)	Clock Cycle Count	Transform Time (μs)
256	3437	3906	39168	20	24	231	256	1.11
1024	3857	4650	155904	20	24	244	1024	4.19
4096 ⁽¹⁾	3719	4734	622848	76	24	234	4096	17.52

Note to Table 1-4:

(1) EP3C40F780C6 device.

Table 1-5 shows the variable streaming data flow performance, with in order inputs and bit-reversed outputs, for width 16 (32 for floating point), for Cyclone III (EP3C16F484C6) devices.



The variable streaming with fixed-point number representation uses natural word growth, therefore the multiplier requirement is larger compared with the equivalent streaming FFT with the same number of points.

If you want to significantly reduce M9K memory utilization, set a lower f_{MAX} target.

Table 1-5. Performance with the Variable Streaming Data Flow Engine Architecture—Cyclone III Devices

Point Type	Points	Combinational LUTs	Logic Registers	Memory (Bits)	Memory (M9K)	9 × 9 Blocks	f _{MAX} (MHz)	Clock Cycle Count	Transform Time (μs)
Fixed	256	3859	4373	9997	15	40	191	256	1.34
Fixed	1024	5243	5840	41940	21	56	193	1024	5.29
Fixed	4096	6725	7369	170335	40	72	198	4096	20.67
Floating ⁽¹⁾	256	20771	14158	34464	62	96	116	256	2.20
Floating ⁽²⁾	1024	26573	17540	140410	93	128	116	1024	8.83
Floating ⁽²⁾	4096	32428	20939	568163	148	160	116	4096	35.3

Note to Table 1-5:

(1) EP3C40F780C6 device.

(2) EP3C55F780C6 device.

Table 1-6 lists resource usage with buffered burst data flow architecture, using the 4 multipliers/2 adders complex multiplier structure, for data and twiddle width 16, for Cyclone III (EP3C25F324C6) devices.

Table 1-6. Resource Usage with Buffered Burst Data Flow Architecture—Cyclone III Devices (Part 1 of 2)

Points	Number of Engines ⁽¹⁾	Combinational LUTs	Logic Registers	Memory (Bits)	Memory (M9K)	9 × 9 Blocks	f _{MAX} (MHz)
256 ⁽²⁾	1	3129	3778	30,76	16	24	247
1024 ⁽²⁾	1	3234	3976	123136	16	24	241

Table 1-6. Resource Usage with Buffered Burst Data Flow Architecture—Cyclone III Devices (Part 2 of 2)

Points	Number of Engines ⁽¹⁾	Combinational LUTs	Logic Registers	Memory (Bits)	Memory (M9K)	9 × 9 Blocks	f _{MAX} (MHz)
4096	1	3291	4160	491776	60	24	227
256 ⁽³⁾	2	5161	5961	30976	31	48	225
1024 ⁽³⁾	2	5270	6169	123136	31	48	207
4096	2	5337	6361	491776	60	48	215
256	4	9015	10738	30976	60	96	230
1024	4	9145	10963	123136	60	96	230
4096	4	9241	11169	491776	60	96	215

Notes to Table 1-6:

- (1) When using the buffered burst architecture, you can specify the number of quad-output FFT engines in the FFT parameter editor.
- (2) EP3C10F256C6 device.
- (3) EP3C16F484C6 device.

Table 1-7 lists performance with buffered burst data flow architecture, using the 4 multipliers/2 adders complex multiplier structure, for data and twiddle width 16, for Cyclone III (EP3C25F324C6) devices.

Table 1-7. Performance with the Buffered Burst Data Flow Architecture—Cyclone III Devices

Points	Number of Engines ⁽¹⁾	f _{MAX} (MHz)	Transform Calculation Time ⁽²⁾		Data Load & Transform Calculation		Block Throughput ⁽³⁾	
			Cycles	Time (μs)	Cycles	Time (μs)	Cycles	Time (μs)
256 ⁽⁴⁾	1	247	235	0.95	491	1.99	331	1.34
1024 ⁽⁴⁾	1	241	1069	4.44	2093	8.69	1291	5.36
4096	1	227	5167	22.81	9263	40.9	6157	27.18
256 ⁽⁵⁾	2	225	162	0.72	397	1.77	299	1.33
1024 ⁽⁵⁾	2	207	557	2.69	1581	7.63	1163	5.61
4096	2	215	2,07	12.12	6703	31.17	5133	23.87
256	4	230	118	0.51	347	1.51	283	1.23
1024	4	230	340	1.48	1364	5.93	1099	4.78
4096	4	215	1378	6.4	5474	25.4	4633	21.5

Notes to Table 1-7:

- (1) When using the buffered burst architecture, you can specify the number of quad-output engines in the FFT parameter editor. You may choose from one, two, or four quad-output engines in parallel.
- (2) In a buffered burst data flow architecture, transform time is defined as the time from when the N-sample input block is loaded until the first output sample is ready for output. Transform time does not include the additional N-1 clock cycle to unload the full output data block.
- (3) Block throughput is the minimum number of cycles between two successive start-of-packet (sink_sop) pulses.
- (4) EP3C10F256C6 device.
- (5) EP3C16F484C6 device.

Table 1-8 lists resource usage with burst data flow architecture, using the 4 multipliers/2 adders complex multiplier structure, for data and twiddle width 16, for Cyclone III (EP3C10F256C6) devices.

Table 1-8. Resource Usage with the Burst Data Flow Architecture—Cyclone III Devices

Points	Engine Architecture	Number of Engines ⁽²⁾	Combinational LUTs	Logic Registers	Memory (Bits)	Memory (M9K)	9 × 9 Blocks	f _{MAX} (MHz)
256	Quad Output	1	3120	3694	14592	8	24	232
1024	Quad Output	1	3227	3876	57600	8	24	246
4096	Quad Output	1	3277	4044	229632	28	24	215
256	Quad Output	2	5141	5872	14592	15	48	244
1024	Quad Output	2	5248	6064	57600	15	48	216
4096	Quad Output	2	5304	6240	229632	28	48	219
256	Quad Output	4	9012	10659	14592	28	96	225
1024	Quad Output	4	9144	10868	57600	28	96	202
4096	Quad Output	4	9241	11058	229632	28	96	204
256	Single Output	1	1449	1499	9472	3	8	250
1024	Single Output	1	1518	1545	37120	6	8	223
4096	Single Output	1	1598	1591	147712	19	8	227
256	Single Output	2	2131	2460	14592	9	16	235
1024	Single Output	2	2185	2536	57600	11	16	221
4096	Single Output	2	2237	2612	229632	28	16	219

Note to Table 1-8:

- (1) When using the burst data flow architecture, you can specify the number of engines in the FFT parameter editor. You may choose from one to two single-output engines in parallel, or from one, two, or four quad-output engines in parallel.

Table 1-9 lists performance with burst data flow architecture, using the 4 multipliers/2 adders complex multiplier structure, for data and twiddle width 16, for Cyclone III (EP3C10F256C6) devices.

Table 1-9. Performance with the Burst Data Flow Architecture—Cyclone III Devices (Part 1 of 2)

Points	Engine Architecture	Number of Engines ⁽¹⁾	f _{MAX} (MHz)	Transform Calculation Time ⁽²⁾		Data Load & Transform Calculation		Block Throughput ⁽³⁾	
				Cycles	Time (μs)	Cycles	Time (μs)	Cycles	Time (μs)
256	Quad Output	1	232	235	1.01	491	2.12	331	1.43
1024	Quad Output	1	246	1069	4.35	2093	8.51	1291	5.25
4096	Quad Output	1	215	5167	24.07	9263	43.15	6157	28.68
256	Quad Output	2	244	162	0.66	397	1.63	299	1.23
1024	Quad Output	2	216	557	2.58	1581	7.31	1163	5.38
4096	Quad Output	2	219	2607	11.9	6703	30.59	5133	23.43
256	Quad Output	4	225	118	0.52	374	1.66	283	1.26
1024	Quad Output	4	202	340	1.68	1364	6.75	1099	5.43
4096	Quad Output	4	204	1378	6.76	5474	26.87	4633	22.74
256	Single Output	1	250	1115	4.45	1371	5.48	1628	6.5

Table 1-9. Performance with the Burst Data Flow Architecture—Cyclone III Devices (Part 2 of 2)

Points	Engine Architecture	Number of Engines ⁽¹⁾	f _{MAX} (MHz)	Transform Calculation Time ⁽²⁾		Data Load & Transform Calculation		Block Throughput ⁽³⁾	
				Cycles	Time (μs)	Cycles	Time (μs)	Cycles	Time (μs)
1024	Single Output	1	223	5230	23.43	6344	28.42	7279	32.6
4096	Single Output	1	227	24705	108.7	28801	126.73	32898	144.75
256	Single Output	2	235	585	2.49	841	3.58	1098	4.67
1024	Single Output	2	221	2652	12	3676	16.64	4701	21.28
4096	Single Output	2	219	12329	56.28	16495	75.3	20605	94.06

Notes to Table 1-9:

- (1) In the burst I/O data flow architecture, you can specify the number of engines in the FFT parameter editor. You may choose from one to two single-output engines in parallel, or from one, two, or four quad-output engines in parallel.
- (2) Transform time is the time frame when the input block is loaded until the first output sample (corresponding to the input block) is output. Transform time does not include the time to unload the full output data block.
- (3) Block throughput is defined as the minimum number of cycles between two successive start-of-packet (*s_{in}k_{_}sop*) pulses.

Stratix III Devices

Table 1-10 lists the streaming data flow performance, using the 4 multipliers/2 adders complex multiplier structure, for data and twiddle width 16, for Stratix III (EP3SE50F780C2) devices.

Table 1-10. Performance with the Streaming Data Flow Engine Architecture—Stratix III Devices

Points	Combinational ALUTs	Logic Registers	Memory (Bits)	Memory (M9K)	18 × 18 Blocks	f _{MAX} (MHz)	Clock Cycle Count	Transform Time (μs)
256	2094	3715	39168	20	12	442	256	0.58
1024	2480	4458	155904	20	12	413	10024	2.48
4096	2357	4545	622848	76	12	388	4096	10.57

Table 1-11 lists the variable streaming data flow performance, with in order inputs and bit-reversed outputs, for width 16 (32 for floating point), for Stratix III (EP3SE50F780C2) devices.



The variable streaming with fixed-point number representation uses natural word growth, therefore the multiplier requirement is larger compared with the equivalent streaming FFT with the same number of points.

If you want to significantly reduce M9K memory utilization, set a lower f_{MAX} target.

Table 1-11. Performance with the Variable Streaming Data Flow Engine Architecture—Stratix III Devices (Part 1 of 2)

Point Type	Points	Combinational ALUTs	Logic Registers	Memory (Bits)	Memory (M9K)	18 × 18 Blocks	f _{MAX} (MHz)	Clock Cycle Count	Transform Time (μs)
Fixed	256	2511	3927	10239	16	20	341	256	0.75
Fixed	1024	3476	5244	42218	23	28	323	1024	3.17
Fixed	4096	4480	6628	170639	42	36	320	4096	12.8
Floating	256	14059	13424	34728	64	48	303	256	0.84

Table 1-11. Performance with the Variable Streaming Data Flow Engine Architecture—Stratix III Devices (Part 2 of 2)

Point Type	Points	Combinational ALUTs	Logic Registers	Memory (Bits)	Memory (M9K)	18 × 18 Blocks	f _{MAX} (MHz)	Clock Cycle Count	Transform Time (μs)
Floating	1024	18019	16560	140750	95	64	286	1024	3.58
Floating ⁽¹⁾	4096	22026	19717	568579	150	80	286	4096	14.33

Note to Table 1-11:

(1) EP3SL70F780C2 device.

Table 1-12 lists resource usage with buffered burst data flow architecture, using the 4 multipliers/2 adders complex multiplier structure, for data and twiddle width 16, for Stratix III (EP3SE50F780C2) devices.

Table 1-12. Resource Usage with Buffered Burst Data Flow Architecture—Stratix III Devices

Points	Number of Engines ⁽¹⁾	Combinational ALUTs	Logic Registers	Memory (Bits)	Memory (M9K)	18 × 18 Blocks	f _{MAX} (MHz)
256	1	1952	3586	30976	16	12	408
1024	1	1989	3784	123136	16	12	390
4096	1	2031	3968	491776	60	12	382
256	2	3261	5577	30976	31	24	365
1024	2	3306	5785	123136	31	24	369
4096	2	3348	5977	491776	60	24	390
256	4	5712	9971	30976	60	48	341
1024	4	5775	10195	123136	60	48	349
4096	4	5857	10403	491776	60	48	325

Note to Table 1-12:

(1) When using the buffered burst architecture, you can specify the number of quad-output FFT engines in the FFT parameter editor.

Table 1-13 lists performance with buffered burst data flow architecture, using the 4 multipliers/2 adders complex multiplier structure, for data and twiddle width 16, for Stratix III (EP3SE50F780C2) devices.

Table 1-13. Performance with the Buffered Burst Data Flow Architecture—Stratix III Devices (Part 1 of 2)

Points	Number of Engines ⁽¹⁾	f _{MAX} (MHz)	Transform Calculation ⁽²⁾		Data Load & Transform Calculation		Block Throughput ⁽³⁾	
			Cycles	Time (μs)	Cycles	Time (μs)	Cycles	Time (μs)
256	1	408	235	0.58	491	1.2	331	0.81
1024	1	390	1069	2.74	2093	5.37	1291	3.31
4096	1	382	5167	13.54	9263	24.27	6157	16.13
256	2	365	162	0.44	397	1.09	299	0.82
1024	2	369	557	1.51	1581	4.29	1163	3.15
4096	2	390	2607	6.68	6703	17.17	5133	13.15
256	4	341	118	0.35	347	1.02	283	0.83
1024	4	349	340	0.98	1364	3.91	1099	3.15

Table 1-13. Performance with the Buffered Burst Data Flow Architecture—Stratix III Devices (Part 2 of 2)

Points	Number of Engines ⁽¹⁾	f _{MAX} (MHz)	Transform Calculation Time ⁽²⁾		Data Load & Transform Calculation		Block Throughput ⁽³⁾	
			Cycles	Time (μs)	Cycles	Time (μs)	Cycles	Time (μs)
4096	4	325	1378	4.25	5474	16.87	4633	14.27

Notes to Table 1-13:

- (1) When using the buffered burst architecture, you can specify the number of quad-output engines in the FFT parameter editor. You may choose from one, two, or four quad-output engines in parallel.
- (2) In a buffered burst data flow architecture, transform time is defined as the time from when the N-sample input block is loaded until the first output sample is ready for output. Transform time does not include the additional N-1 clock cycle to unload the full output data block.
- (3) Block throughput is the minimum number of cycles between two successive start-of-packet (sink_sop) pulses.

Table 1-14 lists resource usage with burst data flow architecture, using the 4 multipliers/2 adders complex multiplier structure, for data and twiddle width 16, for Stratix III (EP3SE50F780C2) devices.

Table 1-14. Resource Usage with the Burst Data Flow Architecture—Stratix III Devices

Points	Engine Architecture	Number of Engines ⁽²⁾	Combinational ALUTs	Logic Registers	Memory (Bits)	Memory (M9K)	18 × 18 Blocks	f _{MAX} (MHz)
256	Quad Output	1	1796	3502	14592	8	12	408
1024	Quad Output	1	1830	3686	57600	8	12	429
4096	Quad Output	1	1882	3852	229632	28	12	410
256	Quad Output	2	2968	5489	14592	15	24	382
1024	Quad Output	2	3015	5681	57600	15	24	388
4096	Quad Output	2	3054	5856	229632	28	24	386
256	Quad Output	4	5162	9891	14592	28	48	348
1024	Quad Output	4	5213	10100	57600	28	48	380
4096	Quad Output	4	5283	10290	229632	28	48	367
256	Single Output	1	704	1435	9472	3	4	438
1024	Single Output	1	740	1481	37120	6	4	414
4096	Single Output	1	805	1527	147712	19	4	404
256	Single Output	2	1037	2332	14592	9	8	413
1024	Single Output	2	1050	2408	57600	11	8	402
4096	Single Output	2	1092	2484	229632	28	8	406

Notes to Table 1-14:

- (1) Represents data and twiddle factor precision.
- (2) When using the burst data flow architecture, you can specify the number of engines in the FFT parameter editor. You may choose from one to two single-output engines in parallel, or from one, two, or four quad-output engines in parallel.

Table 1-15 lists performance with burst data flow architecture, using the 4 multipliers/2 adders complex multiplier structure, for data and twiddle width 16, for Stratix III (EP3SE50F780C2) devices.

Table 1-15. Performance with the Burst Data Flow Architecture—Stratix III Devices

Points	Engine Architecture	Number of Engines ⁽¹⁾	f _{max} (MHz)	Transform Calculation Time ⁽²⁾		Data Load & Transform Calculation		Block Throughput ⁽³⁾	
				Cycles	Time (μs)	Cycles	Time (μs)	Cycles	Time (μs)
256	Quad Output	1	408	235	0.58	491	1.2	331	0.81
1024	Quad Output	1	429	1069	2.49	2093	4.87	1291	3.01
4096	Quad Output	1	410	5167	12.6	9263	22.59	6157	15.02
256	Quad Output	2	382	162	0.42	397	1.04	299	0.78
1024	Quad Output	2	388	557	1.43	1581	4.07	1163	3.00
4096	Quad Output	2	386	2607	6.76	6703	17.39	5133	13.31
256	Quad Output	4	348	118	0.34	374	1.07	283	0.81
1024	Quad Output	4	380	340	0.9	1364	3.59	1099	2.9
4096	Quad Output	4	367	1378	3.76	5474	14.92	4633	12.63
256	Single Output	1	438	1115	2.54	1371	3.13	1628	3.72
1024	Single Output	1	414	5230	12.63	6344	15.31	7279	17.57
4096	Single Output	1	404	24705	61.22	28801	71.37	32898	81.52
256	Single Output	2	413	585	1.42	841	2.04	1098	2.66
1024	Single Output	2	402	2652	6.6	3676	9.15	4701	11.71
4096	Single Output	2	406	12329	30.34	16495	40.59	20605	50.71

Notes to Table 1-15:

- (1) In the burst I/O data flow architecture, you can specify the number of engines in the FFT parameter editor. You may choose from one to two single-output engines in parallel, or from one, two, or four quad-output engines in parallel.
- (2) Transform time is the time frame when the input block is loaded until the first output sample (corresponding to the input block) is output. Transform time does not include the time to unload the full output data block.
- (3) Block throughput is defined as the minimum number of cycles between two successive start-of-packet (*s_{in}k_{_}sop*) pulses.

Stratix IV Devices

Table 1-16 lists the streaming data flow performance, using the 4 multipliers/2 adders complex multiplier structure, for data and twiddle width 16, for Stratix IV (EP4SGX70DF29C2X) devices.

Table 1-16. Performance with the Streaming Data Flow Engine Architecture—Stratix IV Devices

Points	Combinational ALUTs	Logic Registers	Memory (Bits)	Memory (M9K)	18 × 18 Blocks	f _{MAX} (MHz)	Clock Cycle Count	Transform Time (μs)
256	2092	3714	39,68	20	12	436	256	0.59
1024	2480	4458	155904	20	12	437	1024	2.34
4096	2356	4545	622848	76	12	419	4096	9.78

Table 1-17 lists the variable streaming data flow performance, with in order inputs and bit-reversed outputs, for width 16 (32 for floating point), for Stratix IV (EP4SGX70DF29C2X) devices.

 The variable streaming with fixed-point number representation uses natural word growth, therefore the multiplier requirement is larger compared with the equivalent streaming FFT with the same number of points.

If you want to significantly reduce M9K memory utilization, set a lower f_{MAX} target.

Table 1-17. Performance with the Variable Streaming Data Flow Engine Architecture—Stratix IV Devices

Point Type	Points	Combinational ALUTs	Logic Registers	Memory		18 × 18 Blocks	f_{MAX} (MHz)	Clock Cycle Count	Transform Time (μ s)
				Bits	M9K				
Fixed	256	2517	4096	10239	10	20	323	256	0.79
Fixed	1024	3489	5433	42218	15	28	329	1024	3.12
Fixed	4096	4503	6936	170639	33	36	327	4096	12.52
Floating	256	18024	16714	140750	61	48	320	256	0.8
Floating	1024	14063	13502	34728	89	64	314	1024	3.26
Floating	4096	22030	19806	568579	146	80	310	4096	13.23

Table 1-18 lists resource usage with buffered burst data flow architecture, using the 4 multipliers/2 adders complex multiplier structure, for data and twiddle width 16, for Stratix IV (EP4SGX70DF29C2X) devices.

Table 1-18. Resource Usage with Buffered Burst Data Flow Architecture—Stratix IV Devices

Points	Number of Engines ⁽¹⁾	Combinational ALUTs	Logic Registers	Memory (Bits)	Memory (M9K)	18 × 18 Blocks	f_{MAX} (MHz)
256	1	1951	3586	30976	16	12	443
1024	1	1990	3784	123136	16	12	441
4096	1	2034	3968	491776	60	12	421
256	2	3262	5577	30976	31	24	428
1024	2	3307	5785	123136	31	24	410
4096	2	3348	5977	491776	60	24	393
256	4	5712	9970	30976	60	48	368
1024	4	5774	10195	123136	60	48	362
4096	4	5856	10401	491776	60	48	368

Notes to Table 1-18:

(1) When using the buffered burst architecture, you can specify the number of quad-output FFT engines in the FFT parameter editor.

Table 1-19 lists performance with buffered burst data flow architecture, using the 4 multipliers/2 adders complex multiplier structure, for data and twiddle width 16, for Stratix IV (EP4SGX70DF29C2X) devices.

Table 1-19. Performance with the Buffered Burst Data Flow Architecture—Stratix IV Devices (Part 1 of 2)

Points	Number of Engines ⁽¹⁾	f_{MAX} (MHz)	Transform Calculation Time ⁽²⁾		Data Load & Transform Calculation		Block Throughput ⁽³⁾	
			Cycles	Time (μ s)	Cycles	Time (μ s)	Cycles	Time (μ s)
256	1	443	235	0.53	491	1.11	331	0.75
1024	1	441	1069	2.42	2093	4.75	1291	2.93

Table 1-19. Performance with the Buffered Burst Data Flow Architecture—Stratix IV Devices (Part 2 of 2)

Points	Number of Engines ⁽¹⁾	f _{MAX} (MHz)	Transform Calculation Time ⁽²⁾		Data Load & Transform Calculation		Block Throughput ⁽³⁾	
			Cycles	Time (μs)	Cycles	Time (μs)	Cycles	Time (μs)
4096	1	421	5167	12.26	9263	21.98	6157	14.61
256	2	428	162	0.38	397	0.93	299	0.7
1024	2	410	557	1.36	1581	3.85	1163	2.84
4096	2	393	2607	6.64	6703	17.07	5133	13.07
256	4	368	118	0.32	347	0.94	283	0.77
1024	4	362	340	0.94	1364	3.77	1099	3.04
4096	4	368	1378	3.75	5474	14.89	4633	12.61

Notes to Table 1-19:

- (1) When using the buffered burst architecture, you can specify the number of quad-output engines in the FFT parameter editor. You may choose from one, two, or four quad-output engines in parallel.
- (2) In a buffered burst data flow architecture, transform time is defined as the time from when the N-sample input block is loaded until the first output sample is ready for output. Transform time does not include the additional N-1 clock cycle to unload the full output data block.
- (3) Block throughput is the minimum number of cycles between two successive start-of-packet (sink_sop) pulses.

Table 1-20 lists resource usage with burst data flow architecture, using the 4 multipliers/2 adders complex multiplier structure, for data and twiddle width 16, for Stratix IV (EP4SGX70DF29C2X) devices.

Table 1-20. Resource Usage with the Burst Data Flow Architecture—Stratix IV Devices

Points	Engine Architecture	Number of Engines ⁽²⁾	Combinational ALUTs	Logic Registers	Memory (Bits)	Memory (M9K)	18 × 18 Blocks	f _{MAX} (MHz)
256	Quad Output	1	1794	3502	14592	8	12	436
1024	Quad Output	1	1829	3684	57600	8	12	446
4096	Quad Output	1	1881	3852	229632	28	12	443
256	Quad Output	2	2968	5489	14592	15	24	418
1024	Quad Output	2	3014	5680	57600	15	24	412
4096	Quad Output	2	3053	5856	229632	28	24	366
256	Quad Output	4	5160	9891	14592	28	48	369
1024	Quad Output	4	5218	10101	57600	28	48	385
4096	Quad Output	4	5284	10290	229632	28	48	380
256	Single Output	1	704	1436	9472	3	4	407
1024	Single Output	1	740	1482	37120	6	4	413
4096	Single Output	1	801	1528	147712	19	4	412
256	Single Output	2	1036	2332	14592	9	8	405
1024	Single Output	2	1052	2408	57600	11	8	431
4096	Single Output	2	1092	2484	229632	28	8	406

Notes to Table 1-20:

- (1) Represents data and twiddle factor precision.
- (2) When using the burst data flow architecture, you can specify the number of engines in the FFT parameter editor. You may choose from one to two single-output engines in parallel, or from one, two, or four quad-output engines in parallel.

Table 1–21 lists performance with burst data flow architecture, using the 4 multipliers/2 adders complex multiplier structure, for data and twiddle width 16, for Stratix IV (EP4SGX70DF29C2X) devices.

Table 1–21. Performance with the Burst Data Flow Architecture—Stratix IV Devices

Points	Engine Architecture	Number of Engines ⁽¹⁾	f _{MAX} (MHz)	Transform Calculation Time ⁽²⁾		Data Load & Transform Calculation		Block Throughput ⁽³⁾	
				Cycles	Time (μs)	Cycles	Time (μs)	Cycles	Time (μs)
256	Quad Output	1	436	235	0.54	491	1.12	331	0.76
1024	Quad Output	1	446	1069	2.39	2093	4.69	1291	2.89
4096	Quad Output	1	443	5167	11.66	9263	20.9	6157	13.89
256	Quad Output	2	418	162	0.39	397	0.95	299	0.71
1024	Quad Output	2	412	557	1.35	1581	3.83	1163	2.82
4096	Quad Output	2	366	2607	7.12	6703	18.3	5133	14.01
256	Quad Output	4	369	118	0.32	374	1.01	283	0.77
1024	Quad Output	4	385	340	0.88	1364	3.55	1099	2.86
4096	Quad Output	4	380	1378	3.63	5474	14.42	4633	12.20
256	Single Output	1	407	1115	2.74	1371	3.37	1628	4.00
1024	Single Output	1	413	5230	12.66	6344	15.35	7279	17.62
4096	Single Output	1	412	24705	59.91	28801	69.84	32898	79.78
256	Single Output	2	405	585	1.45	841	2.08	1098	2.71
1024	Single Output	2	431	2652	6.16	3676	8.54	4701	10.92
4096	Single Output	2	406	12329	30.35	16495	40.61	20605	50.73

Notes to Table 1–21:

- (1) In the burst I/O data flow architecture, you can specify the number of engines in the FFT parameter editor. You may choose from one to two single-output engines in parallel, or from one, two, or four quad-output engines in parallel.
- (2) Transform time is the time frame when the input block is loaded until the first output sample (corresponding to the input block) is output. Transform time does not include the time to unload the full output data block.
- (3) Block throughput is defined as the minimum number of cycles between two successive start-of-packet (*s_{in}k_{_}s_op*) pulses.

Stratix V Devices

Table 1–22 lists the streaming data flow performance, using the 4 multipliers/2 adders complex multiplier structure, for data and twiddle width 16, for Stratix V (5SGXEA7H3F35C2) devices.

Table 1–22. Performance with the Streaming Data Flow Engine Architecture—Stratix V Devices

Points	Combinational ALUTs	Logic Registers	Memory (Bits)	Memory (M20K)	DSP Blocks	f _{MAX} (MHz)	Clock Cycle Count	Transform Time (μs)
256	2,093	3,944	39,168	20	6	395	256	0.65
1024	2,489	4,719	155,904	20	6	382	1,024	2.68
4096	2,352	4,801	622,848	38	6	370	4,096	11.08

Table 1-23 lists the variable streaming data flow performance, with in order inputs and bit-reversed outputs, for width 16 (32 for floating point), for Stratix V (5SGXEA7H3F35C2) devices.



The variable streaming with fixed-point number representation uses natural word growth, therefore the multiplier requirement is larger compared with the equivalent streaming FFT with the same number of points.

If you want to significantly reduce M20K memory utilization, set a lower f_{MAX} target.

Table 1-23. Performance with the Variable Streaming Data Flow Engine Architecture—Stratix V Devices

Point Type	Points	Combinational ALUTs	Logic Registers	Memory		DSP Blocks	f_{MAX} (MHz)	Clock Cycle Count	Transform Time (μ s)
				Bits	M20K				
Fixed	256	2,543	4,319	10,239	15	10	348	256	0.73
Fixed	1024	3,518	5,724	42,204	20	14	330	1,024	3.1
Fixed	4096	4,568	7,290	170,537	31	18	331	4,096	12.36
Floating	256	15,017	15,778	34,445	62	24	334	256	0.77
Floating	1024	19,239	19,551	141,114	91	32	323	1,024	3.17
Floating	4096	23,402	23,295	571,894	121	40	320	4,096	12.82

Table 1-24 lists resource usage with buffered burst data flow architecture, using the 4 multipliers/2 adders complex multiplier structure, for data and twiddle width 16, for Stratix V (5SGXEA7H3F35C2) devices.

Table 1-24. Resource Usage with Buffered Burst Data Flow Architecture—Stratix IV Devices

Points	Number of Engines ⁽¹⁾	Combinational ALUTs	Logic Registers	Memory (Bits)	Memory (M20K)	DSP Blocks	f_{MAX} (MHz)
256	1	1,958	3,828	30,976	16	6	430
1024	1	1,997	4,042	123,136	16	6	403
4096	1	2,031	4,235	491,776	30	6	402
256	2	3,264	6,053	30,976	30	12	380
1024	2	3,310	6,247	123,136	30	12	379
4096	2	3,344	6,462	491,776	30	12	366
256	4	5,715	10,897	30,976	59	24	337
1024	4	5,776	11,115	123,136	59	24	348
4096	4	5,857	11,341	491,776	59	24	312

Note to Table 1-24:

- (1) When using the buffered burst architecture, you can specify the number of quad-output FFT engines in the FFT parameter editor.

Table 1-25 lists performance with buffered burst data flow architecture, using the 4 multipliers/2 adders complex multiplier structure, for data and twiddle width 16, for Stratix V (5SGXEA7H3F35C2) devices.

Table 1-25. Performance with the Buffered Burst Data Flow Architecture—Stratix V Devices

Points	Number of Engines ⁽¹⁾	f _{MAX} (MHz)	Transform Calculation Time ⁽²⁾		Data Load & Transform Calculation		Block Throughput ⁽³⁾	
			Cycles	Time (μs)	Cycles	Time (μs)	Cycles	Time (μs)
256	1	430	235	0.55	491	1.14	331	0.77
1024	1	403	1,069	2.65	2,093	5.19	1,291	3.2
4096	1	402	5,167	12.86	9,263	23.06	6,157	15.32
256	2	380	162	0.43	397	1.05	299	0.79
1024	2	379	557	1.47	1,581	4.17	1,163	3.07
4096	2	366	2,607	7.13	6,703	18.33	5,133	14.04
256	4	337	118	0.35	347	1.03	283	0.84
1024	4	348	340	0.98	1,364	3.92	1,099	3.16
4096	4	312	1,378	4.42	5,474	17.54	4,633	14.84

Notes to Table 1-25:

- (1) When using the buffered burst architecture, you can specify the number of quad-output engines in the FFT parameter editor. You may choose from one, two, or four quad-output engines in parallel.
- (2) In a buffered burst data flow architecture, transform time is defined as the time from when the N-sample input block is loaded until the first output sample is ready for output. Transform time does not include the additional N-1 clock cycle to unload the full output data block.
- (3) Block throughput is the minimum number of cycles between two successive start-of-packet (sink_sop) pulses.

Table 1-26 lists resource usage with burst data flow architecture, using the 4 multipliers/2 adders complex multiplier structure, for data and twiddle width 16, for Stratix V (5SGXEA7H3F35C2) devices.

Table 1-26. Resource Usage with the Burst Data Flow Architecture—Stratix V Devices (Part 1 of 2)

Points	Engine Architecture	Number of Engines ⁽²⁾	Combinational ALUTs	Logic Registers	Memory (Bits)	Memory (M20K)	DSP Blocks	f _{MAX} (MHz)
256	Quad Output	1	1,801	3,717	14,592	8	6	414
1024	Quad Output	1	1,833	3,912	57,600	8	6	405
4096	Quad Output	1	1,878	4,078	229,632	14	6	395
256	Quad Output	2	2,970	5,914	14,592	14	12	385
1024	Quad Output	2	3,019	6,129	57,600	14	12	395
4096	Quad Output	2	3,048	6,319	229,632	14	12	374
256	Quad Output	4	5,164	10,743	14,592	27	24	353
1024	Quad Output	4	5,216	10,924	57,600	27	24	314
4096	Quad Output	4	5,280	11,129	229,632	27	24	346
256	Single Output	1	709	1,542	9,472	3	2	445
1024	Single Output	1	751	1,598	37,120	4	2	443
4096	Single Output	1	817	1,637	147,712	9	2	427
256	Single Output	2	1,037	2,521	14,592	8	4	401
1024	Single Output	2	1,052	2,622	57,600	8	4	443

Table 1-26. Resource Usage with the Burst Data Flow Architecture—Stratix V Devices (Part 2 of 2)

Points	Engine Architecture	Number of Engines ⁽²⁾	Combinational ALUTs	Logic Registers	Memory (Bits)	Memory (M20K)	DSP Blocks	f _{MAX} (MHz)
4096	Single Output	2	1,093	2,700	229,632	14	4	366

Notes to Table 1-20:

- (1) Represents data and twiddle factor precision.
- (2) When using the burst data flow architecture, you can specify the number of engines in the FFT parameter editor. You may choose from one to two single-output engines in parallel, or from one, two, or four quad-output engines in parallel.

Table 1-27 lists performance with burst data flow architecture, using the 4 multipliers/2 adders complex multiplier structure, for data and twiddle width 16, for Stratix V (5SGXEA7H3F35C2) devices.

Table 1-27. Performance with the Burst Data Flow Architecture—Stratix V Devices

Points	Engine Architecture	Number of Engines ⁽¹⁾	f _{MAX} (MHz)	Transform Calculation Time ⁽²⁾		Data Load & Transform Calculation		Block Throughput ⁽³⁾	
				Cycles	Time (μs)	Cycles	Time (μs)	Cycles	Time (μs)
256	Quad Output	1	414	235	0.57	491	1.18	331	0.8
1024	Quad Output	1	405	1,069	2.64	2,093	5.17	1,291	3.19
4096	Quad Output	1	395	5,167	13.08	9,263	23.44	6,157	15.58
256	Quad Output	2	385	162	0.42	397	1.03	299	0.78
1024	Quad Output	2	395	557	1.41	1,581	4	1,163	2.94
4096	Quad Output	2	374	2,607	6.98	6,703	17.94	5,133	13.74
256	Quad Output	4	353	118	0.33	374	1.06	283	0.8
1024	Quad Output	4	314	340	1.08	1,364	4.35	1,099	3.5
4096	Quad Output	4	346	1,378	3.99	5,474	15.84	4,633	13.4
256	Single Output	1	445	1,115	2.51	1,371	3.08	1,628	3.66
1024	Single Output	1	443	5,230	11.79	6,344	14.31	7,279	16.41
4096	Single Output	1	427	24,705	57.86	28,801	67.45	32,898	77.05
256	Single Output	2	401	585	1.46	841	2.1	1,098	2.74
1024	Single Output	2	443	2,652	5.99	3,676	8.3	4,701	10.61
4096	Single Output	2	366	12,239	33.67	16,495	45.05	20,605	56.27

Notes to Table 1-27:

- (1) In the burst I/O data flow architecture, you can specify the number of engines in the FFT parameter editor. You may choose from one to two single-output engines in parallel, or from one, two, or four quad-output engines in parallel.
- (2) Transform time is the time frame when the input block is loaded until the first output sample (corresponding to the input block) is output. Transform time does not include the time to unload the full output data block.
- (3) Block throughput is defined as the minimum number of cycles between two successive start-of-packet (*s_{ink_sop}*) pulses.

Installation and Licensing

The FFT MegaCore function is part of the MegaCore® IP Library, which is distributed with the Quartus® II software and can be downloaded from the Altera® website, www.altera.com.

- For system requirements and installation instructions, refer to the *Altera Software Installation and Licensing* manual.

Figure 1–1 shows the directory structure after you install the FFT MegaCore function, where *<path>* is the installation directory for the Quartus II software.

The default installation directory on Windows is `c:\altera\<version>` and on Linux is `/opt/altera<version>`.

Figure 1–1. Directory Structure

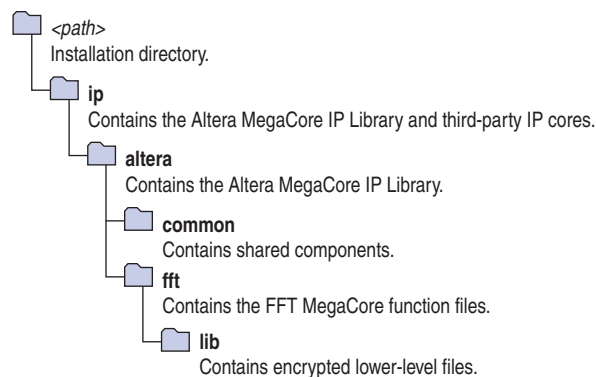

OpenCore Plus Evaluation

With Altera’s free OpenCore Plus evaluation feature, you can perform the following actions:

- Simulate the behavior of a megafunction (Altera MegaCore function or AMPPSM megafunction) within your system.
- Verify the functionality of your design, as well as evaluate its size and speed quickly and easily.
- Generate time-limited device programming files for designs that include megafunctions.
- Program a device and verify your design in hardware.

You only need to purchase a license for the FFT MegaCore function when you are completely satisfied with its functionality and performance, and want to take your design to production. After you purchase a license, you can request a license file from the Altera website at www.altera.com/licensing and install it on your computer. When you request a license file, Altera emails you a **license.dat** file. If you do not have Internet access, contact your local Altera representative.

- For more information about OpenCore Plus hardware evaluation, refer to *AN 320: OpenCore Plus Evaluation of Megafunctions*.

OpenCore Plus Time-Out Behavior

OpenCore Plus hardware evaluation supports the following operation modes:

- —the design runs for a limited time.
- —requires a connection between your board and the host computer. If tethered mode is supported by all megafunctions in a design, the device can operate for a longer time or indefinitely.

All megafunctions in a device time-out simultaneously when the most restrictive evaluation time is reached. If there is more than one megafunction in a design, a specific megafunction's time-out behavior might be masked by the time-out behavior of the other megafunctions.

The untethered time-out for the FFT MegaCore function is one hour; the tethered time-out value is indefinite.

The signals `source_real`, `source_imag`, and `source_exp` are forced low when the evaluation time expires.

Design Flows

The FFT MegaCore function supports the following design flows:

- **DSP Builder:** Use this flow if you want to create a DSP Builder model that includes a FFT MegaCore function variation.
- **MegaWizard™ Plug-In Manager:** Use this flow if you would like to create a FFT MegaCore function variation that you can instantiate manually in your design.

This chapter describes how you can use a FFT MegaCore function in either of these flows. The parameterization provides the same options in each flow and is described in [“Parameterize the MegaCore Function” on page 2–3](#).

After parameterizing and simulating a design in either of these flows, you can compile the completed design in the Quartus II software.

DSP Builder Flow

Altera’s DSP Builder product shortens digital signal processing (DSP) design cycles by helping you create the hardware representation of a DSP design in an algorithm-friendly development environment.

DSP Builder integrates the algorithm development, simulation, and verification capabilities of The MathWorks MATLAB® and Simulink® system-level design tools with Altera Quartus® II software and third-party synthesis and simulation tools. You can combine existing Simulink blocks with Altera DSP Builder blocks and MegaCore function variation blocks to verify system level specifications and perform simulation.

In DSP Builder, a Simulink symbol for the MegaCore function appears in the MegaCore Functions library of the Altera DSP Builder Blockset in the Simulink library browser.

You can use the FFT MegaCore function in the MATLAB/Simulink environment by performing the following steps:

1. Create a new Simulink model.
2. Select the `fft_< >` block from the MegaCore Functions library in the Simulink Library Browser, add it to your model, and give the block a unique name.
3. Double-click on the `fft_< >` block in your model to display the parameter editor and parameterize the MegaCore function variation. For an example of setting parameters for the FFT MegaCore function, refer to [“Parameterize the MegaCore Function” on page 2–3](#).
4. Click **Finish** in the parameter editor to complete the parameterization and generate your FFT MegaCore function variation. For information about the generated files, refer to [Table 2–1 on page 2–11](#).
5. Connect your FFT MegaCore function variation to the other blocks in your model.

6. Simulate the MegaCore function variation in your DSP Builder model.

 For more information about the DSP Builder flow, refer to the chapter in the *DSP Builder User Guide*.

 When you are using the DSP Builder flow, device selection, simulation, Quartus II compilation and device programming are all controlled within the DSP Builder environment.

DSP Builder supports integration with SOPC Builder using Avalon® Memory-Mapped (Avalon-MM) master/slave and Avalon Streaming (Avalon-ST) source/sink interfaces.

 For more information about these interface types, refer to the *Avalon Interface Specifications*.

MegaWizard Plug-In Manager Flow

The MegaWizard™ Plug-in Manager flow allows you to customize an FFT MegaCore function, and manually integrate the MegaCore function variation into a Quartus II design.

Follow the steps below to use the MegaWizard Plug-in Manager flow.

1. Create a new project using the **New Project Wizard** available from the File menu in the Quartus II software.
2. Launch **MegaWizard Plug-in Manager** from the Tools menu, and select the option to create a new custom megafunction variation ([Figure 2-1](#)).

Figure 2-1. MegaWizard Plug-In Manager

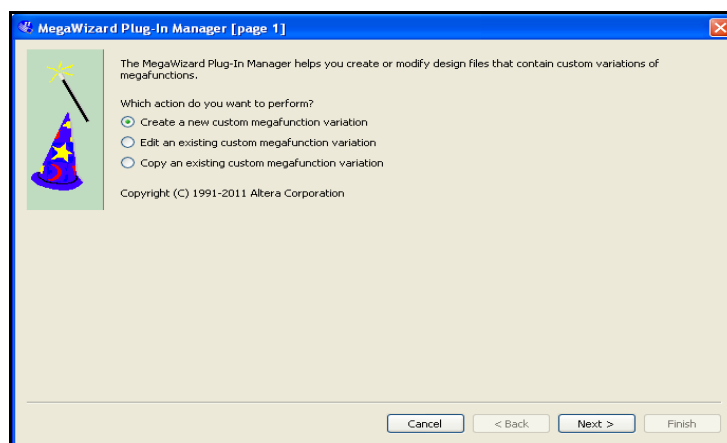

3. Click **Next** and select **FFT <version>** from the **DSP>Transforms** section in the **Installed Plug-Ins** tab.
4. Verify that the device family is the same as you specified in the **New Project Wizard**.

5. Select the top-level output file type for your design; the wizard supports VHDL and Verilog HDL.
6. The MegaWizard Plug-In Manager shows the project path that you specified in the **New Project Wizard**. Append a variation name for the MegaCore function output files `<project path>\<variation name>`. **Figure 2-2** shows the wizard after you have made these settings.

Figure 2-2. Select the MegaCore Function

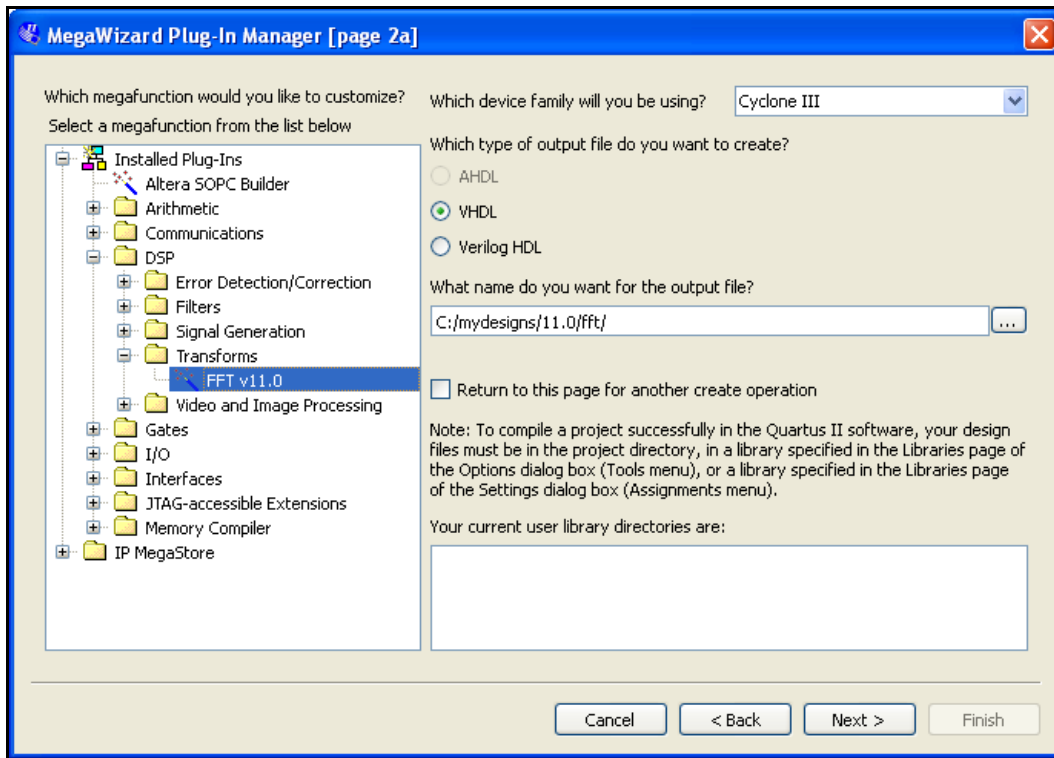

7. Click **Next** to launch IP Toolbench.

Parameterize the MegaCore Function

To parameterize your MegaCore function, follow these steps:

1. Click **Step 1: Parameterize** in IP Toolbench (Figure 2-3 on page 2-4).

Figure 2-3. IP Toolbench—Parameterize

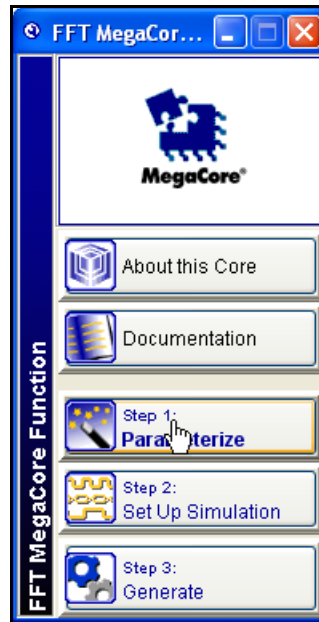

2. Do not change the **Target Device Family**. The device family is automatically set to the value that was specified in your Quartus II project and the generated HDL for your MegaCore function variation may be incorrect if this value is changed (Figure 2-4).

Figure 2-4. Parameters Tab

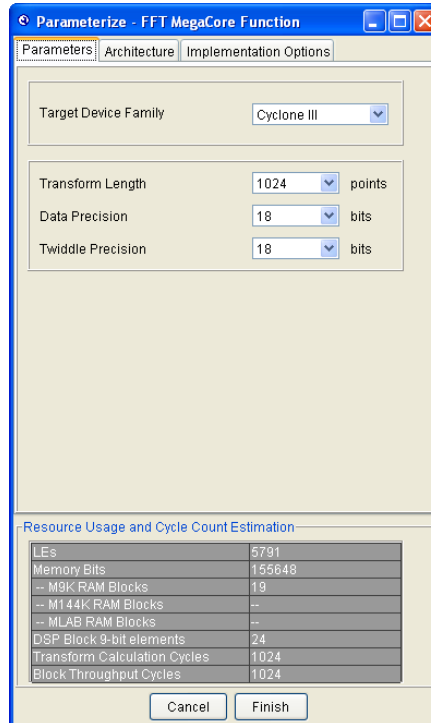

3. Choose the **Transform length**, **Data precision**, and **Twiddle precision**.



The twiddle factor precision must be less than or equal to the data precision.

- Click the **Architecture** tab (Figure 2-5).

Figure 2-5. Architecture Tab

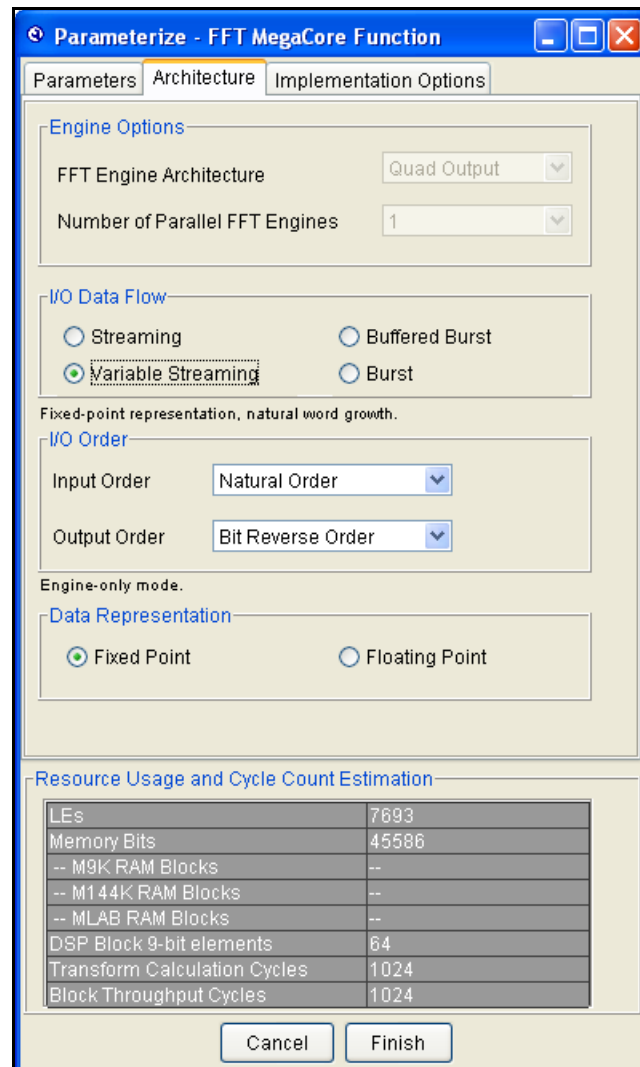

- Choose the FFT engine architecture, number of parallel FFT engines, and the I/O data flow.

If you select the **Streaming** I/O data flow, the FFT MegaCore function automatically generates a design with a **Quad Output** FFT engine architecture and the minimum number of parallel FFT engines for the required throughput.

 A single FFT engine architecture provides enough performance for up to a 1,024-point streaming I/O data flow FFT.

If you select **Variable Streaming** I/O data flow, the **Transform length** (specified on the **Parameters** Tab) represents the maximum transform length that can be performed. All transforms of length 2^m where $6 \leq m \leq \log_2(\text{transform length})$ can be performed at runtime.



If you select **Variable Streaming** and **Floating Point** on the **Architecture** tab, the precision (on the **Parameters** tab) is automatically set to 32, and the reverse I/O order options (on the **Architecture** tab) are **Digit Reverse Order**.

If you select **Variable Streaming** I/O data flow, options to set the I/O order and data representation are visible. The **Input Order** option allow you to select the order in which the samples are presented to the FFT. If you select **Natural Order**, the FFT expects the order of the input samples to be sequential (1, 2 ..., $n - 1$, n) where n is the size of the current transform. For **Bit Reverse Order**, the FFT expects the input samples to be in bit-reversed order. For **Digit Reverse Order**, the FFT expects the input samples to be in digit-reversed order. For $-N/2$ to $N/2$, the FFT expects the input samples to be in the order $-N/2$ to $(N/2) - 1$ (also known as DC-centered order). Similarly the **Output Order** option specifies the order in which the FFT generates the output. Whether you can select **Bit Reverse Order** or **Digit Reverse Order** depends on your **Data Representation** selection. You can select **Fixed Point** or **Floating Point** data representation. If you select **Fixed Point**, the FFT variation implements the radix-2² architecture and the reverse I/O order option is **Bit Reverse Order**; if you select **Floating Point**, the FFT variation implements the mixed radix-4/2 architecture and the reverse I/O order option is **Digit Reverse Order**.

For sample digit-reversed order, if n is a power of four, the order is radix-4 digit-reversed order, in which two-bit digits in the sample number are units in the reverse ordering. For example, if $n = 16$, sample number 4 becomes the second sample in the sample stream (by reversal of the digits in 0001, the location in the sample stream, to 0100). However, in mixed radix-4/2 architecture, n need not be a power of four. If n is not a power of four, the two-bit digits are grouped from the least significant bit, and the most significant bit becomes the least significant bit in the digit-reversed order. For example, if $n = 512$, the sample at location [8][76][54][32][10] in the digit-reversed sample stream is sample number [10][32][54][76][8] in the natural ordering. The 261st sample in the stream, at location 260 (100000100), is the sample that is number 33 (000100001) in the natural ordering.

- Click the **Implementation Options** tab (Figure 2-6).

Figure 2-6. Implementation Options Tab

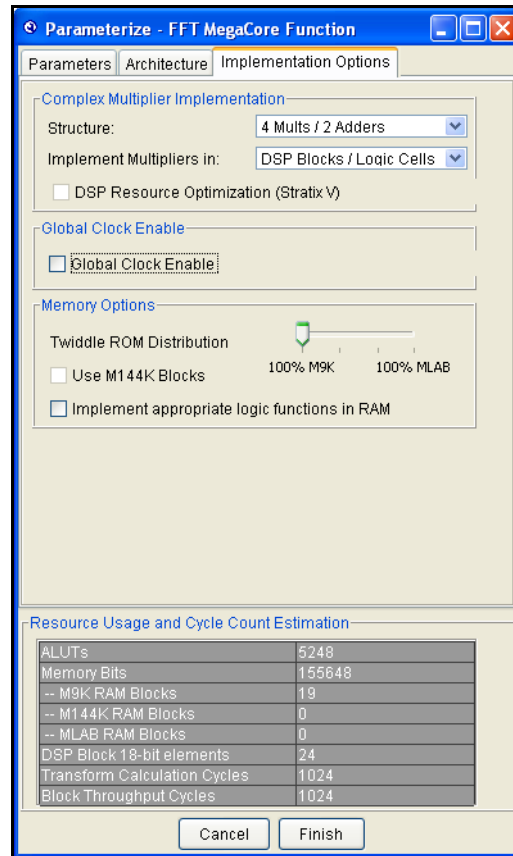

- Choose the complex multiplier implementation.

You can choose a **Structure** with three multipliers and five adders or four multipliers and two adders. You can also choose to **Implement Multipliers in** DSP blocks only, logic cells only or both DSP blocks and logic cells. If your FFT variation targets a Stratix V device, you can turn on **DSP Resource Optimization**. This option optimizes for area rather than speed by utilizing the new Stratix V DSP block complex 18×25 and 27×27 multiplication modes. In the variable streaming architecture using the floating point representation, the option utilizes the DSP block complex 27×27 multiplication mode at the potential expense of lower accuracy.

 The complex multiplier implementation options **Structure** and **Implement Multipliers in** are not available for the variable streaming architecture. The complex multiplier implementation option **DSP Resource Optimization** is available only in Stratix V devices.

If you turn on **DSP Resource Optimization**, and your variation has data precision between 18 and 25 bits, inclusive, and twiddle precision less than or equal to 18 bits, the FFT MegaCore function configures the DSP blocks in complex 18×25 multiplication mode. If you turn on DSP Resource Optimization and your variation does not meet these criteria, the FFT MegaCore function configures the DSP blocks based on the criteria it uses when you do not turn on the option. The FFT MegaCore function configures the Stratix V device according to the following criteria when you turn off the option or it is not available:

- If data precision and twiddle precision are both less than or equal to 27 bits, configures 3/4 of a DSP block in complex 27×27 multiplication mode. This configuration uses only three of the four DSP rows in a single DSP block.
- If data precision is greater than 27 bits and twiddle precision is less than or equal to 18 bits, configures one DSP block in sum of two 18×36 multiplication mode. This configuration uses four DSP rows.
- Otherwise, configures two DSP blocks in 36×36 multiplication mode. This configuration uses eight DSP rows in two DSP blocks.

 For more information about the Stratix V DSP block modes, refer to the *Variable Precision DSP Blocks in Stratix V Devices* chapter in the *Stratix V Device Handbook*.

8. Turn on **Global Clock Enable**, if you want to add a global clock enable to your design.
9. Specify the memory options.

You can set memory use balance with the **Twiddle ROM Distribution**, turn on **Use M-RAM Blocks**, and turn on **Implement appropriate logic functions in RAM**. If your FFT variation targets an appropriate device family, the **Use M144K Blocks** option replaces the **Use M-RAM Blocks** option.

 The memory options are not available for the variable streaming architecture. The memory options **Twiddle ROM Distribution** and **Use M-RAM Blocks** are not available in the Cyclone series of device families (the Cyclone, Cyclone II, Cyclone III, Cyclone III LS, and Cyclone IV device families).

10. Click **Finish** when the implementation options are set.

 For more information about the FFT MegaCore function parameters, refer to [Table 3-3 on page 3-14](#).

Set Up Simulation

An IP functional simulation model is a cycle-accurate VHDL or Verilog HDL model produced by the Quartus II software. The model allows for fast functional simulation of IP using industry-standard VHDL and Verilog HDL simulators.



You may only use these simulation model output files for simulation purposes and expressly not for synthesis or any other purposes. Using these models for synthesis creates a nonfunctional design.

To generate an IP functional simulation model for your MegaCore function, follow these steps:

1. Click **Step 2: Set Up Simulation** in IP Toolbench (Figure 2-3 on page 2-4).
2. Turn on **Generate Simulation Model** (Figure 2-7 on page 2-10).
3. Choose the required language in the **Language list**.
4. Some third-party synthesis tools can use a netlist that contains only the structure of the MegaCore function, but not detailed logic, to optimize performance of the design that contains the MegaCore function. If your synthesis tool supports this feature, turn on **Generate netlist**.
5. Click **OK**.

Figure 2-7. Generate Simulation Model

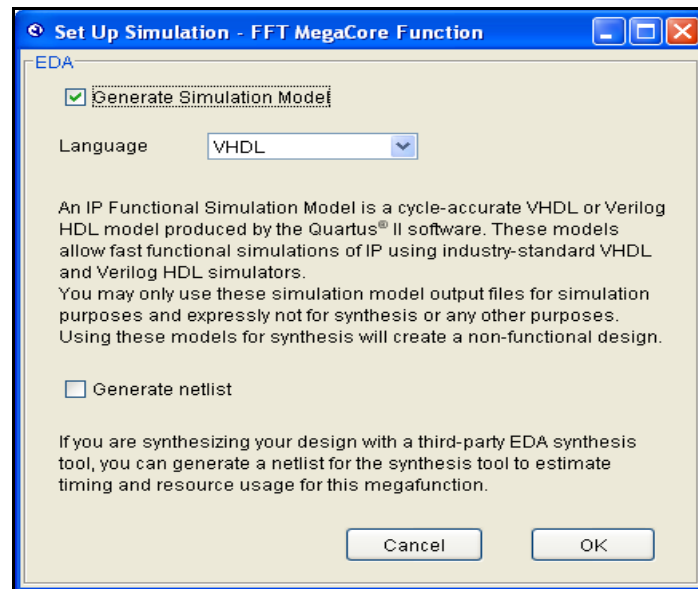

Generate the MegaCore Function

To generate your MegaCore function, follow these steps:

1. Click **Step 3: Generate** in IP Toolbench (Figure 2-3 on page 2-4).

The generation phase may take several minutes to complete. The generation progress and status is displayed in a report window.

Figure 2-8 shows the generation report.

Figure 2-8. Generation Report

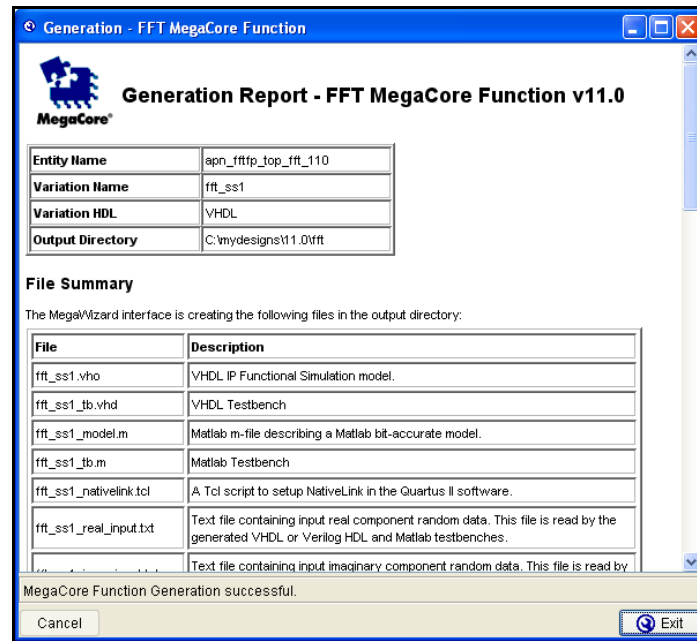

Table 2-1 describes the generated files and other files that may be in your project directory. The names and types of files specified in the IP Toolbench report vary based on whether you created your design with VHDL or Verilog HDL

Table 2-1. Generated Files (Part 1 of 2) (1) & (2)

Filename	Description
<i><variation name></i> _imag_input.txt	The text file contains input imaginary component random data. This file is read by the generated VHDL or Verilog HDL MATLAB testbenches.
<i>variation name</i> real_input.txt	Test file containing real component random data. This file is read by the generated VHDL or Verilog HDL and MATLAB testbenches.
<i>variation name</i> .bsf	Quartus II symbol file for the MegaCore function variation. You can use this file in the Quartus II block diagram editor.
<i><variation name></i> .cmp	A VHDL component declaration file for the MegaCore function variation. Add the contents of this file to any VHDL architecture that instantiates the MegaCore function.
<i><variation name></i> .html	A MegaCore function report file in hypertext markup language format.
<i><variation name></i> .qip	A single Quartus II IP file is generated that contains all of the assignments and other information required to process your MegaCore function variation in the Quartus II compiler. You are prompted to add this file to the current Quartus II project when you exit from the MegaWizard.
<i><variation name></i> .vo or .vho	VHDL or Verilog HDL IP functional simulation model.

Table 2-1. Generated Files (Part 2 of 2) ⁽¹⁾ & ⁽²⁾

Filename	Description
<variation name>.vhd, or .v	A MegaCore function variation file, which defines a VHDL or Verilog HDL top-level description of the custom MegaCore function. Instantiate the entity defined by this file inside of your design. Include this file when compiling your design in the Quartus II software.
variation name _1n1024cos.hex, variation name _2n1024cos.hex, variation name _3n1024cos.hex	Intel hex-format ROM initialization files (not generated for variable streaming FFT).
variation name _1n1024sin.hex, variation name _2n1024sin.hex, variation name _3n1024sin.hex	Intel hex-format ROM initialization files (not generated for variable streaming FFT).
variation name _model.m	MATLAB m-file describing a MATLAB bit-accurate model.
variation name _tb.m	MATLAB testbench.
variation name _syn.v or variation name _syn.vhd	A timing and resource netlist for use in some third-party synthesis tools.
<variation name>_tb.v or <variation name>_tb.vhd	Verilog HDL or VHDL testbench file.
<variation name>_nativelink.tcl	Tcl Script that sets up NativeLink in the Quartus II software to natively simulate the design using selected EDA tools. Refer to “ Simulating in Third-Party Simulation Tools Using NativeLink ” on page 2-15.
<variation name>_twr1_opt.hex, <variation name>_twi1_opt.hex, <variation name>_twr2_opt.hex, <variation name>_twi2_opt.hex, <variation name>_twr3_opt.hex, <variation name>_twi3_opt.hex, <variation name>_twr4_opt.hex, <variation name>_twi4_opt.hex,	Intel hex-format ROM initialization files (variable streaming FFT only).
Notes to Table 2-1:	
(1) These files are variation dependent, some may be absent or their names may change.	
(2) <variation name> is a prefix variation name supplied automatically by IP Toolbench.	

- After you review the generation report, click **Exit** to close IP Toolbench. Then click **Yes** on the **Quartus II IP Files** prompt to add the .qip file describing your custom MegaCore function to the current Quartus II project.

 Refer to the Quartus II Help for more information about the MegaWizard Plug-In Manager.

You can now integrate your custom MegaCore function variation into your design and simulate and compile.

Simulate the Design

This section describes the following simulation techniques:

- [Simulate in the MATLAB Software](#)
- [Simulate with IP Functional Simulation Models](#)

- [Simulating in Third-Party Simulation Tools Using NativeLink](#)

Simulate in the MATLAB Software

This section discusses fixed-transform and variable streaming architecture simulations.

Fixed Transform Architectures

The FFT MegaCore function outputs a bit-accurate MATLAB model `<variation name>_model.m`, which you can use to model the behavior of your custom FFT variation in the MATLAB software. The model takes a complex vector as input and it outputs the transform-domain complex vector and corresponding block exponent values. The length and direction of the transform (FFT/IFFT) are also passed as inputs to the model.

If the input vector length is an integral multiple of N , the transform length, the length of the output vector(s) is equal to the length of the input vector. However, if the input vector is not an integral multiple of N , it is zero-padded to extend the length to be so.

 For additional information about exponent values, refer to [AN 404: FFT/IFFT Block Floating Point Scaling](#).

The wizard also creates the MATLAB testbench file `<variation name>_tb.m`. This file creates the stimuli for the MATLAB model by reading the input complex random data from IP Toolbench-generated.

If you selected **Floating point** data representation, the input data is generated in hexadecimal format.

To model your fixed-transform architecture FFT MegaCore function variation in the MATLAB software, follow these steps:

1. Run the MATLAB software.
2. In the MATLAB command window, change to the working directory for your project.
3. Perform the simulation:
 - a. Type `help <variation name>_model` at the command prompt to view the input and output vectors that are required to run the MATLAB model as a standalone M-function. Create your input vector and make a function call to `< >_model`. For example:

```
N=2048;
INVERSE = 0; % 0 => FFT 1=> IFFT
x = (2^12)*rand(1,N) + j*(2^12)*rand(1,N);
[y,e] = <variation name>_model(x,N,INVERSE);
```

or
 - b. Run the provided testbench by typing the name of the testbench, `< >_tb` at the command prompt.

 For more information about MATLAB and Simulink, refer to the MathWorks web site at www.mathworks.com.

Variable Streaming Architecture

The FFT MegaCore function outputs a bit-accurate MATLAB model <

>_model.m, which you can use to model the behavior of your custom FFT variation in the MATLAB software. The model takes a complex vector as input and it outputs the transform-domain complex vector. The lengths and direction of the transforms (FFT/IFFT) (specified as one entry per block) are also passed as an input to the model.

You must ensure that the length of the input vector is at least as large as the sum of the transform sizes for the model to function correctly.

The wizard also creates the MATLAB testbench file < >_tb.m. This file creates the stimuli for the MATLAB model by reading the input complex random data from files generated by IP Toolbench.

To model your variable streaming architecture FFT MegaCore function variation in the MATLAB software, follow these steps:

1. Run the MATLAB software.
2. In the MATLAB command window, change to the working directory for your project.
3. Perform the simulation:
 - a. Type `help <variation name>_model` at the command prompt to view the input and output vectors that are required to run the MATLAB model as a standalone M-function. Create your input vector and make a function call to < >_model. For example:

```
nps=[256,2048];
inverse = [0,1]; % 0 => FFT 1=> IFFT
x = (2^12)*rand(1,sum(nps)) + j*(2^12)*rand(1,sum(nps));
[y] = <variation name>_model(x,nps,inverse);
```

or
 - b. Run the provided testbench by typing the name of the testbench, < >_tb at the command prompt.



If you select bit-reversed output order, you can reorder the data with the following MATLAB code:

```
y = y(bit_reverse(0:(FFTSIZE-1), log2(FFTSIZE)) + 1);
```

where `bit_reverse` is:

```
function y = bit_reverse(x, n_bits)
y = bin2dec(fliplr(dec2bin(x, n_bits)));
```



If you select digit-reversed output order, you can reorder the data with the following MATLAB code:

```
y = y(digit_reverse(0:(FFTSIZE-1), log2(FFTSIZE)) + 1);
```

where `digit_reverse` is:

```
function y = digit_reverse(x, n_bits)
if mod(n_bits,2)
    z = dec2bin(x, n_bits);
    for i=1:2:n_bits-1
        p(:,i) = z(:,n_bits-i);
        p(:,i+1) = z(:,n_bits-i+1);
    end

    p(:,n_bits) = z(:,1);
    y=bin2dec(p);
else
    y=digitrevorder(x,4);
end
```

Simulate with IP Functional Simulation Models

To simulate your design, use the IP functional simulation models generated by IP Toolbench. The IP functional simulation model is the `.vo` or `.vho` file generated as specified in [“Set Up Simulation” on page 2-10](#). Compile the `.vo` or `.vho` file in your simulation environment to perform functional simulation of your custom variation of the MegaCore function.

 For more information about IP functional simulation models, refer to the chapter in volume 3 of the Quartus II Handbook.

Simulating in Third-Party Simulation Tools Using NativeLink

You can perform a simulation in a third-party simulation tool from within the Quartus II software, using NativeLink.

 For more information about NativeLink, refer to the [chapter](#) in volume 3 of the *Quartus II Handbook*.

You can use the Tcl script file `<variation name>_nativelink.tcl` to assign default NativeLink testbench settings to the Quartus II project.

To set up simulation in the Quartus II software using NativeLink, follow these steps:

1. Create a custom variation but ensure you specify your variation name to match the Quartus II project name.
2. Check that the absolute path to your third-party simulator executable is set. On the Tools menu click **Options** and select **EDA Tools Options**.
3. On the Processing menu, point to **Start** and click **Start Analysis & Elaboration**.
4. On the Tools menu, click **Tcl scripts**. Select the `<variation name>_nativelink.tcl` Tcl script and click **Run**. Check for a message confirming that the Tcl script was successfully loaded.
5. On the Assignments menu, click **Settings**, expand **EDA Tool Settings** and select **Simulation**. Select a simulator under **Tool Name** and in **NativeLink Settings**, select **Test Benches**.
6. On the Tools menu, point to **EDA Simulation Tool** and click **Run EDA RTL Simulation**.

Use the Quartus II software to synthesize and place and route your design. Refer to Quartus II Help for instructions on performing compilation.

To compile your fixed-transform architecture design, follow these steps:

1. If you are using the Quartus II software to synthesize your design, skip to step 2. If you are using a third-party synthesis tool to synthesize your design, follow these steps:
 - a. Set a black box attribute for your FFT MegaCore function custom variation before you synthesize the design. Refer to Quartus II Help for instructions on setting black-box attributes per synthesis tool.
 - b. Run the synthesis tool to produce an EDIF Netlist File (.edf) or Verilog Quartus Mapping (VQM) file (.vqm) for input to the Quartus II software.
 - c. Add the EDIF or VQM file to your Quartus II project.



The **.qip** file supersedes the files you had to add to the project explicitly in previous versions of the Quartus II software. The **.qip** file contains the information about the MegaCore function that the Quartus II software requires.

2. On the Processing menu, click **Start Compilation**.

To compile your variable streaming architecture design, follow these steps:

1. If you are using the Quartus II software to synthesize your design, skip to step 2. If you are using a third-party synthesis tool to synthesize your design, follow these steps:
 - a. Set a black-box attribute for your FFT MegaCore function custom variation before you synthesize the design. Refer to Quartus II Help for instructions on setting black-box attributes per synthesis tool.
 - b. Run the synthesis tool to produce an EDIF Netlist File (.edf) or Verilog Quartus Mapping (VQM) file (.vqm) for input to the Quartus II software.
 - c. Add the EDIF or VQM file to your Quartus II project.
2. On the Project menu, click **Add/Remove Files in Project**.
3. You can see a list of files in the project. If no files are listed, browse to the \lib directory, then select and add all files with the prefix **auk_dspip_r22sdf**. Browse to the <project> directory and select all files with prefix **auk_dspip**.
4. On the Processing menu, click **Start Compilation**.

After you have compiled your design, program your targeted Altera device, and verify your design in hardware.

With Altera's free OpenCore Plus evaluation feature, you can evaluate the FFT MegaCore function before you purchase a license. OpenCore Plus evaluation allows you to generate an IP functional simulation model, and produce a time-limited programming file.

- For more information about IP functional simulation models, refer to the *Simulating Altera Designs* chapter in volume 3 of the *Quartus II Handbook*.

You can simulate the FFT in your design, and perform a time-limited evaluation of your design in hardware.

- For more information about OpenCore Plus hardware evaluation using the FFT, refer to “OpenCore Plus Evaluation” on page 1–18 and *AN 320: OpenCore Plus Evaluation of Megafunctions*.

The discrete Fourier transform (DFT), of length N , calculates the sampled Fourier transform of a discrete-time sequence at N evenly distributed points $\omega_k = 2\pi k/N$ on the unit circle.

The following equation shows the length- N forward DFT of a sequence $x(n)$:

$$X[k] = \sum_{n=0}^{N-1} x(n)e^{(-j2\pi nk)/N}$$

where $k = 0, 1, \dots, N-1$

The following equation shows the length- N inverse DFT:

$$x(n) = (1/N) \sum_{k=0}^{N-1} X[k]e^{(j2\pi nk)/N}$$

where $n = 0, 1, \dots, N-1$

The complexity of the DFT direct computation can be significantly reduced by using fast algorithms that use a nested decomposition of the summation in equations one and two—in addition to exploiting various symmetries inherent in the complex multiplications. One such algorithm is the Cooley-Tukey radix- r decimation-in-frequency (DIF) FFT, which recursively divides the input sequence into N/r sequences of length r and requires $\log_r N$ stages of computation.

Each stage of the decomposition typically shares the same hardware, with the data being read from memory, passed through the FFT processor and written back to memory. Each pass through the FFT processor is required to be performed $\log_r N$ times. Popular choices of the radix are $r = 2, 4$, and 16 . Increasing the radix of the decomposition leads to a reduction in the number of passes required through the FFT processor at the expense of device resources.

 The MegaCore function does not apply the scaling factor $1/N$ required for a length- N inverse DFT. You must apply this factor externally.

Buffered, Burst, & Streaming Architectures

A radix-4 decomposition, which divides the input sequence recursively to form four-point sequences, has the advantage that it requires only trivial multiplications in the four-point DFT and is the chosen radix in the Altera FFT MegaCore function. This results in the highest throughput decomposition, while requiring non-trivial complex multiplications in the post-butterfly twiddle-factor rotations only. In cases where N is an odd power of two, the FFT MegaCore automatically implements a radix-2 pass on the last pass to complete the transform.

To maintain a high signal-to-noise ratio throughout the transform computation, the FFT MegaCore function uses a block-floating-point architecture, which is a trade-off point between fixed-point and full-floating point architectures.

In a fixed-point architecture, the data precision needs to be large enough to adequately represent all intermediate values throughout the transform computation. For large FFT transform sizes, an FFT fixed-point implementation that allows for word growth can make either the data width excessive or can lead to a loss of precision.

In a floating-point architecture each number is represented as a mantissa with an individual exponent—while this leads to greatly improved precision, floating-point operations tend to demand increased device resources.

In a block-floating point architecture, all of the values have an independent mantissa but share a common exponent in each data block. Data is input to the FFT function as fixed point complex numbers (even though the exponent is effectively 0, you do not enter an exponent).

The block-floating point architecture ensures full use of the data width within the FFT function and throughout the transform. After every pass through a radix-4 FFT, the data width may grow up to $\log_2(4\sqrt{2}) = 2.5$ bits. The data is scaled according to a measure of the block dynamic range on the output of the previous pass. The number of shifts is accumulated and then output as an exponent for the entire block. This shifting ensures that the minimum of least significant bits (LSBs) are discarded prior to the rounding of the post-multiplication output. In effect, the block-floating point representation acts as a digital automatic gain control. To yield uniform scaling across successive output blocks, you must scale the FFT function output by the final exponent.



In comparing the block-floating point output of the Altera FFT MegaCore function to the output of a full precision FFT from a tool like MATLAB, you must scale the output by $2^{(-\text{exponent_out})}$ to account for the discarded LSBs during the transform. (Refer to “Block Floating Point Scaling” on page 4–1.)



For more information about exponent values, refer to [AN 404: FFT/IFFT Block Floating Point Scaling](#).

Variable Streaming Architecture

The variable streaming architecture uses two different types of architecture, depending on whether you select the fixed-point data representation or the floating point representation. If you select the fixed-point data representation, the FFT variation uses a radix 2^2 single delay feedback architecture, which is a fully pipelined architecture. If you select the floating point representation, the FFT variation uses a mixed radix-4/2 architecture. For a length N transform, $\log_4(N)$ stages are concatenated together. The radix 2^2 algorithm has the same multiplicative complexity of a fully pipelined radix-4 architecture, but the butterfly unit retains a radix-2 architecture. In the radix-4/2 algorithm, a combination of radix-4 and radix-2 architectures are implemented to achieve the computational advantage of the radix-4 architecture while supporting FFT computation with a wider range of transform lengths. The butterfly units use the DIF decomposition.

Fixed point representation allows for natural word growth through the pipeline. The maximum growth of each stage is 2 bits. After the complex multiplication the data is rounded down to the expanded data size using convergent rounding. The overall bit growth is less than or equal to $\log_2(N)+1$.

The floating point internal data representation is single precision floating point (32-bit, IEEE 754 representation). Floating point operations provide more precise computation results but are costly in hardware resources. To reduce the amount of logic required for floating point operations, the variable streaming FFT uses "fused" floating point kernels. The reduction in logic occurs by fusing together several floating point operations and reducing the number of normalizations that need to occur.

You can select input and output orders generated by the FFT. Table 3-1 shows the input and output order options.

Table 3-1. Input & Output Order Options

Input Order	Output Order	Mode	Comments
Natural	Bit reversed	Engine-only	Requires minimum memory and minimum latency.
Bit reversed	Natural		
DC-centered	Bit-reversed		
Natural	Natural	Engine with bit-reversal	At the output, requires an extra N complex memory words and an additional N clock cycles latency, where N is the size of the transform.
Bit reversed	Bit reversed		
DC-centered	Natural		

Some applications for the FFT require an FFT > user operation > IFFT chain. In this case, choosing the input order and output order carefully can lead to significant memory and latency savings. For example, consider where the input to the first FFT is in natural order and the output is in bit-reversed order (FFT is operating in engine-only mode). In this example, if the IFFT operation is configured to accept bit-reversed inputs and produces natural order outputs (IFFT is operating in engine-only mode), only the minimum amount of memory is required, which provides a saving of N complex memory words, and a latency saving of N clock cycles, where N is the size of the current transform.

The Avalon Streaming Interface

The Avalon-ST interface defines a standard, flexible, and modular protocol for data transfers from a source interface to a sink interface and simplifies the process of controlling the flow of data in a datapath.

The Avalon-ST interface signals can describe traditional streaming interfaces supporting a single stream of data without knowledge of channels or packet boundaries. Such interfaces typically contain data, ready, and valid signals. The Avalon-ST interface can also support more complex protocols for burst and packet transfers with packets interleaved across multiple channels.

The Avalon-ST interface inherently synchronizes multi-channel designs, which allows you to achieve efficient, time-multiplexed implementations without having to implement complex control logic.

The Avalon-ST interface supports backpressure, which is a flow control mechanism in which a sink can signal to a source to stop sending data. The sink typically uses backpressure to stop the flow of data when its FIFO buffers are full or when there is congestion on its output. When designing a datapath that includes an FFT MegaCore function, you may not need backpressure if you know the downstream components can always receive data. You may achieve a higher clock rate by driving the source ready signal `source_ready` of the FFT high, and not connecting the sink ready signal `sink_ready`.

The FFT MegaCore function has a `READY_LATENCY` value of zero.



For more information about the Avalon-ST interface, refer to the [Avalon Interface Specifications](#).

FFT Processor Engine Architectures

The FFT MegaCore function can be parameterized to use either quad-output or single-output engine architecture. To increase the overall throughput of the FFT MegaCore function, you may also use multiple parallel engines of a variation. This section discusses the following topics:

- Radix 2^2 single-delay feedback architecture for fixed-point variable streaming variations
- Mixed radix-4/2 architecture for floating point variable streaming variations
- Quad-output FFT engine architecture for streaming, buffered burst, and burst variations
- Single-output FFT engine architecture for buffered burst and burst variations

Radix- 2^2 Single Delay Feedback Architecture

Radix- 2^2 single delay feedback architecture is a fully pipelined architecture for calculating the FFT of incoming data. It is similar to radix-2 single delay feedback architectures. However, the twiddle factors are rearranged such that the multiplicative complexity is equivalent to a radix-4 single delay feedback architecture.

There are $\log_2(N)$ stages with each stage containing a single butterfly unit and a feedback delay unit that delays the incoming data by a specified number of cycles, halved at every stage. These delays effectively align the correct samples at the input of the butterfly unit for the butterfly calculations. Every second stage contains a modified radix-2 butterfly whereby a trivial multiplication by $-j$ is performed before the radix-2 butterfly operations. The output of the pipeline is in bit-reversed order.

The following scheduled operations occur in the pipeline for an FFT of length $N = 16$.

1. For the first 8 clock cycles, the samples are fed unmodified through the butterfly unit to the delay feedback unit.
2. The next 8 clock cycles perform the butterfly calculation using the data from the delay feedback unit and the incoming data. The higher order calculations are sent through to the delay feedback unit while the lower order calculations are sent to the next stage.

- The next 8 clock cycles feed the higher order calculations stored in the delay feedback unit unmodified through the butterfly unit to the next stage.

Subsequent data stages use the same principles. However, the delays in the feedback path are adjusted accordingly.

Mixed Radix-4/2 Architecture

Mixed radix-4/2 architecture combines the advantages of using radix-2 and radix-4 butterflies.

The architecture has $\text{ceiling}(\log_4(N))$ stages. If transform length is an integral power of four, all of the $\log_4(N)$ stages are implemented using a radix-4 architecture. If transform length is not an integral power of four, the architecture implements $\text{ceiling}(\log_4(N)) - 1$ of the stages in a radix-4 architecture, and implements the remaining stage using a radix-2 architecture.

Each stage contains a single butterfly unit and a feedback delay unit. The feedback delay unit delays the incoming data by a specified number of cycles; in each stage the number of cycles of delay is one quarter of the number of cycles of delay in the previous stage. The delays align the butterfly input samples correctly for the butterfly calculations. The output of the pipeline is in index-reversed order.

Quad-Output FFT Engine Architecture

For applications in which transform time is to be minimized, a quad-output FFT engine architecture is optimal. The term quad-output refers to the throughput of the internal FFT butterfly processor. The engine implementation computes all four radix-4 butterfly complex outputs in a single clock cycle.

Figure 3–1 shows a diagram of the quad-output FFT engine.

Figure 3–1. Quad-Output FFT Engine

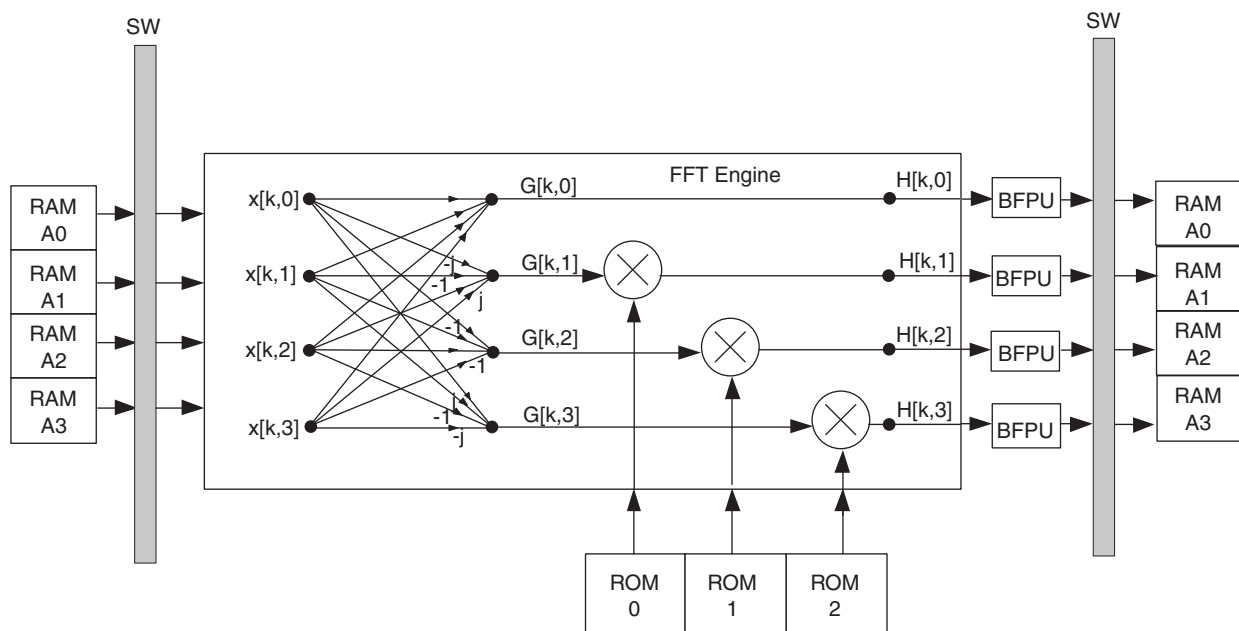

Streaming

The streaming I/O data flow FFT architecture allows continuous processing of input data, and outputs a continuous complex data stream without the requirement to halt the data flow in or out of the FFT function.

Streaming FFT Operation

Figure 3-3 on page 3-7 shows an example simulation waveform.

Following the deassertion of the system reset, the data source asserts `sink_valid` to indicate to the FFT function that valid data is available for input. A successful data transfer occurs when both the `sink_valid` and the `sink_ready` are asserted.

When the data transfer is complete, `sink_sop` is deasserted and the data samples are loaded in natural order.

For more information about the signals, refer to Table 3-4 on page 3-16.

 For more information about the Avalon-ST interface, refer to the *Avalon Interface Specifications*.

Figure 3-3. FFT Streaming Data Flow Architecture Simulation Waveform

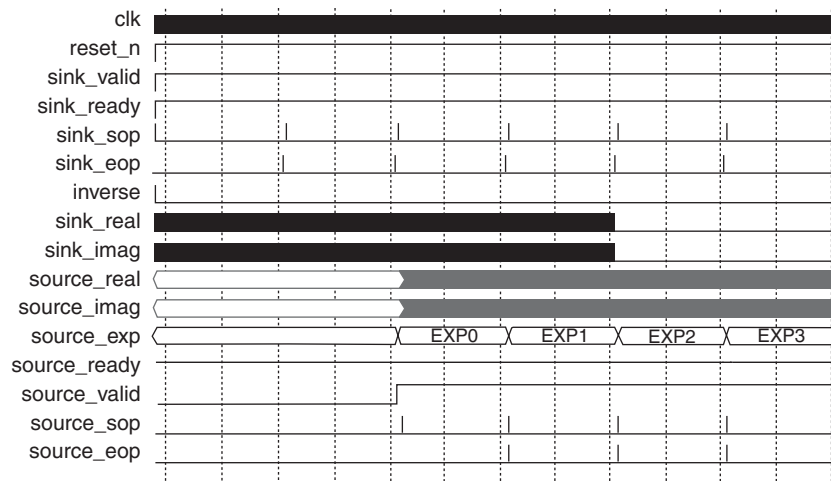
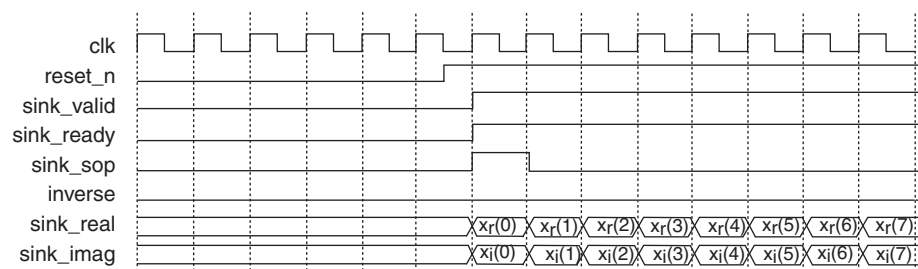

Figure 3-4 shows the input flow control. When the final sample is loaded, the source asserts `sink_eop` and `sink_valid` for the last data transfer.

Figure 3-4. FFT Streaming Data Flow Architecture Input Flow Control



To change direction on a block-by-block basis, assert or deassert `inverse` (appropriately) simultaneously with the application of the `sink_sop` pulse (concurrent with the first input data sample of the block).

When the FFT has completed the transform of the input block, it asserts `source_valid` and outputs the complex transform domain data block in natural order. The FFT function asserts `source_sop` to indicate the first output sample. Figure 3-5 shows the output flow control.

Figure 3-5. FFT Streaming Data Flow Architecture Output Flow Control

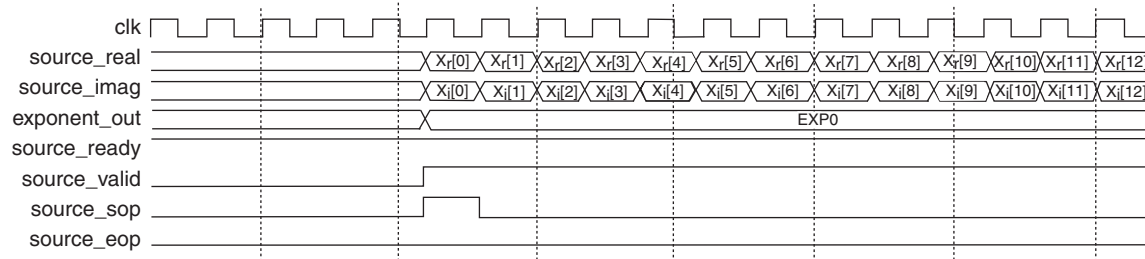

After N data transfers, `source_eop` is asserted to indicate the end of the output data block (Figure 3-3 on page 3-7).

Enabling the Streaming FFT

The `sink_valid` signal must be asserted for `source_valid` to be asserted (and a valid data output). To extract the final frames of data from the FFT, you need to provide several frames where the `sink_valid` signal is asserted and apply the `sink_sop` and `sink_eop` signals in accordance with the Avalon-ST specification.

Variable Streaming

The variable streaming architecture allows continuous streaming of input data and produces a continuous stream of output data similar to the streaming architecture.

Change the Block Size

You change the size of the FFT on a block-by-block basis by changing the value of the `fftpts` simultaneously with the application of the `sink_sop` pulse (concurrent with the first input data sample of the block). `fftpts` uses a binary representation of the size of the transform, therefore for a block with maximum transfer size of 1,024. Table 3-2 shows the value of the `fftpts` signal and the equivalent transform size.

Table 3-2. fftpts and Transform Size

fftpts	Transform Size
1000000000	1,024
0100000000	512
0010000000	256
0001000000	128
0000100000	64

To change direction on a block-by-block basis, assert or deassert `inverse` (appropriately) simultaneously with the application of the `sink_sop` pulse (concurrent with the first input data sample of the block). When the FFT has completed the transform of the input block, it asserts `source_valid` and outputs the complex transform domain data block. The FFT function asserts the `source_sop` to indicate the first output sample. The order of the output data depends on the output order that you select in IP Toolbench. The output of the FFT may be in natural order or bit-reversed order. [Figure 3-6](#) shows the output flow control when the output order is bit-reversed. If the output order is natural order, data flow control remains the same, but the order of samples at the output is in sequential order 1..N.

Figure 3-6. Output Flow Control—Bit Reversed Order

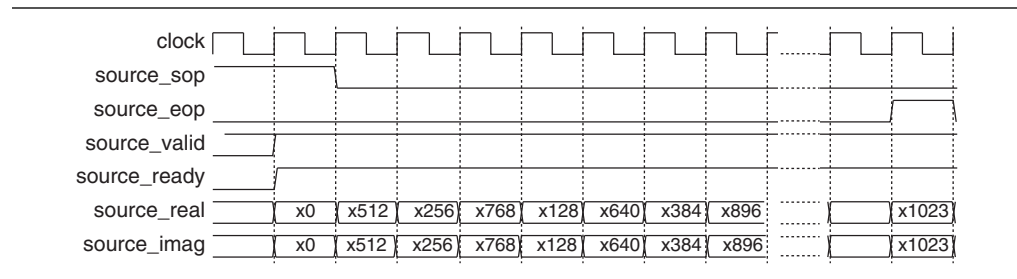

Enabling the Variable Streaming FFT

The FFT processes data when there is valid data transferred to the module (`sink_valid` asserted). [Figure 3-7](#) shows the FFT behavior when `sink_valid` is deasserted.

Figure 3-7. FFT Behavior When `sink_valid` is Deasserted

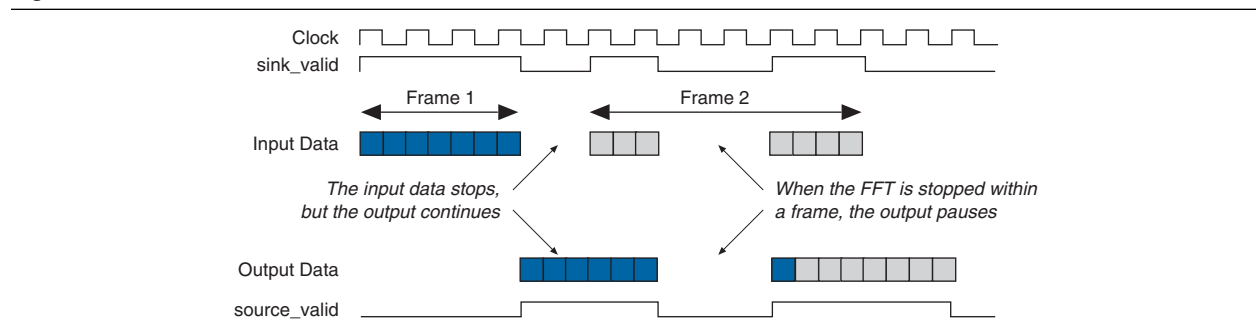

When `sink_valid` is deasserted during a frame, the FFT stalls and no data is processed until `sink_valid` is reasserted. This implies that any previous frames that are still in the FFT also stall.

If `sink_valid` is deasserted between frames, the data currently in the FFT continues to be processed and transferred to the output. [Figure 3-7](#) shows the FFT behavior when `sink_valid` is deasserted between frames and within a frame.

The FFT may optionally be disabled by deasserting the `clk_en` signal.

Dynamically Changing the FFT Size

When the size of the incoming FFT changes, the FFT stalls the incoming data (deasserts the `sink_ready` signal) until all of the previous FFT frames of the previous FFT size have been processed and transferred to the output. Figure 3-8 shows dynamically changing the FFT size for engine-only mode.

Figure 3-8. Dynamically Changing the FFT Size

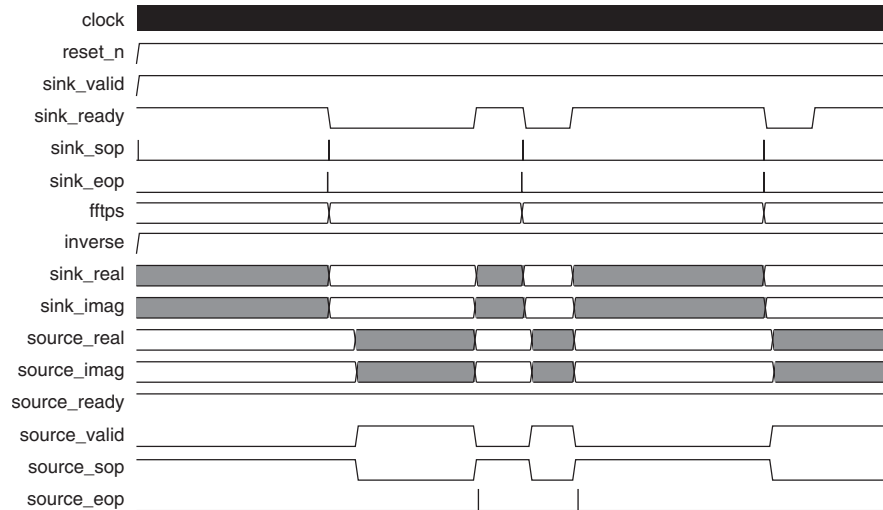

The Effect of I/O Order

The order of samples entering and leaving the FFT is determined by your selection in the **Architecture** tab under **I/O Order**. This selection also determines if the FFT is operating in engine-only mode or engine with bit-reversal or digit-reversal mode.

If the FFT operates in engine-only mode, the output data is available after approximately $N + \text{latency}$ clocks cycles after the first sample was input to the FFT. Latency represents a small latency through the FFT core and depends on the transform size. For engine with bit-reversal mode, the output is available after approximately $2N + \text{latency}$ cycles.

Figure 3-9 shows the data flow output when the FFT is operating in engine-only mode.

Figure 3-9. Data Flow—Engine-Only Mode

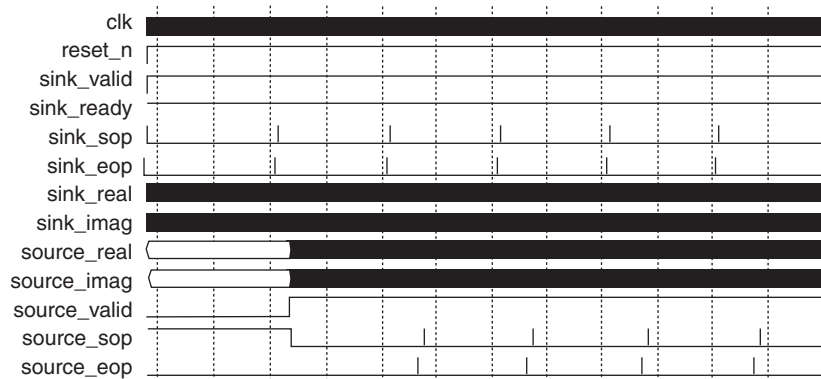
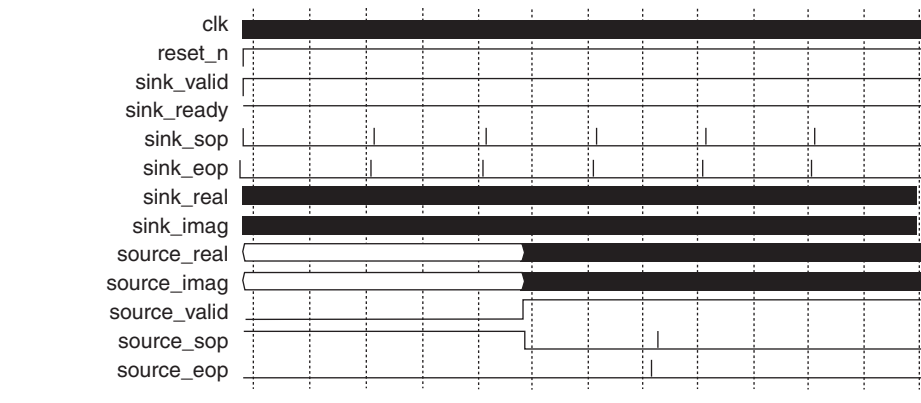

Figure 3-10 shows the data flow output when the FFT is operating in engine with bit-reversal or digit-reversal mode, respectively

Figure 3-10. Data Flow—Engine with Bit-Reversal or Digit-Reversal Mode



Buffered Burst

The buffered burst I/O data flow architecture FFT requires fewer memory resources than the streaming I/O data flow architecture, but the tradeoff is an average block throughput reduction.

Figure 3-11 on page 3-11 shows an example simulation waveform.

Figure 3-11. FFT Buffered Burst Data Flow Architecture Simulation Waveform

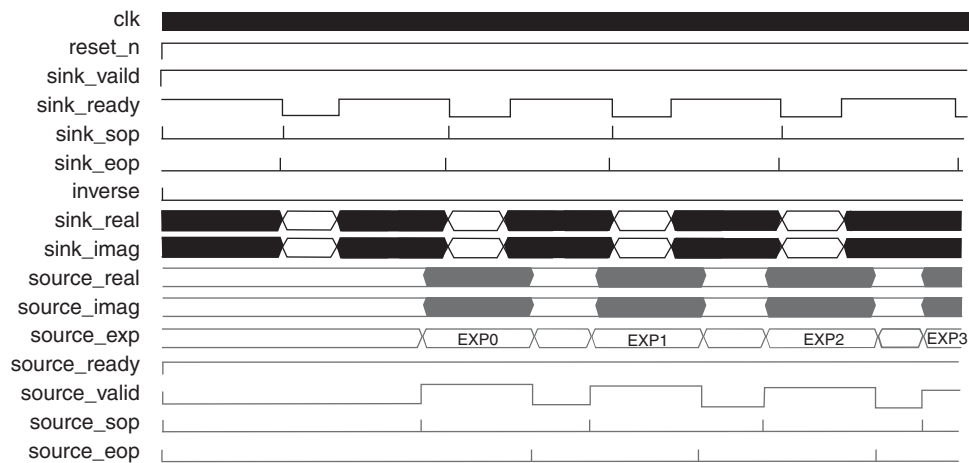

Following the deassertion of the system reset, the data source asserts `sink_valid` to indicate to the FFT function that valid data is available for input. A successful data transfer occurs when both the `sink_valid` and the `sink_ready` are asserted.

The data source loads the first complex data sample into the FFT function and simultaneously asserts `sink_sop` to indicate the start of the input block. On the next clock cycle, `sink_sop` is deasserted and the following $N - 1$ complex input data samples must be loaded in natural order. On the last complex data sample, `sink_eop` must be asserted.

When the input block is loaded, the FFT function begins computing the transform on the stored input block. The `sink_ready` signal is held high as you can transfer the first few samples of the subsequent frame into the small FIFO at the input. If this FIFO is filled, the core deasserts the `sink_ready` signal. It is not mandatory to transfer samples during `sink_ready` cycles. Figure 3-12 shows the input flow control.

Figure 3-12. FFT Buffered Burst Data Flow Architecture Input Flow Control

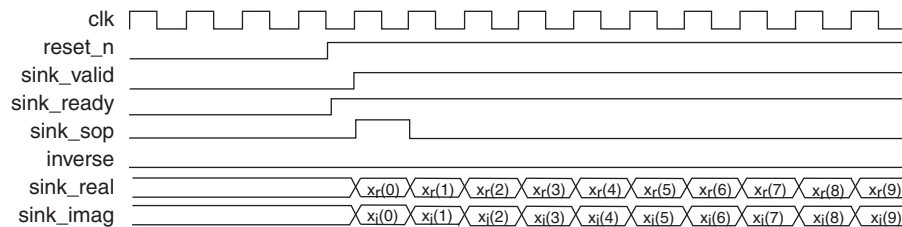

Following the interval of time where the FFT processor reads the input samples from an internal input buffer, it re-asserts `sink_ready` indicating it is ready to read in the next input block. The beginning of the subsequent input block must be demarcated by the application of a pulse on `sink_sop` aligned in time with the first input sample of the next block.

As in all data flow architectures, the logical level of `inverse` for a particular block is registered by the FFT function at the time of the assertion of the start-of-packet signal, `sink_sop`.

When the FFT has completed the transform of the input block, it asserts the `source_valid` and outputs the complex transform domain data block in natural order (Figure 3-13).

Figure 3-13. FFT Buffered Burst Data Flow Architecture Output Flow Control

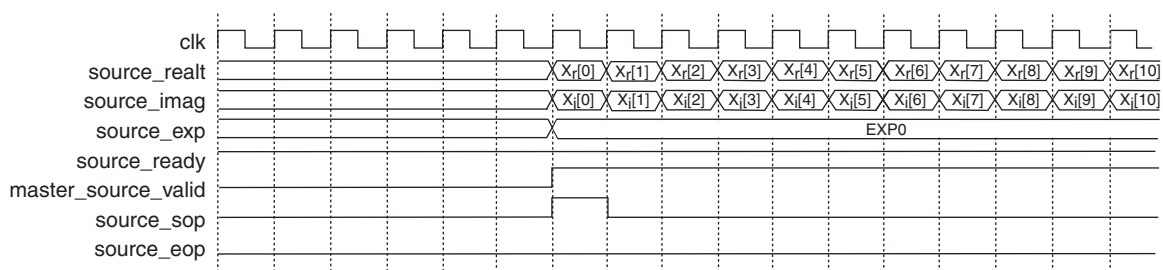

Signals `source_sop` and `source_eop` indicate the start-of-packet and end-of-packet for the output block data respectively (Figure 3-11).

 The `sink_valid` signal must be asserted for `source_valid` to be asserted (and a valid data output). You must therefore leave `sink_valid` signal asserted at the end of data transfers to extract the final frames of data from the FFT.

 For information about enabling the buffered burst FFT, refer to “Enabling the Streaming FFT” on page 3-8.

Burst

The burst I/O data flow architecture operates similarly to the buffered burst architecture, except that the burst architecture requires even lower memory resources for a given parameterization at the expense of reduced average throughput.

Figure 3-14 shows the simulation results for the burst architecture. Again, the signals `source_valid` and `sink_ready` indicate, to the system data sources and slave sinks either side of the FFT, when the FFT can accept a new block of data and when a valid output block is available on the FFT output.

Figure 3-14. FFT Burst Data Flow Architecture Simulation Waveform

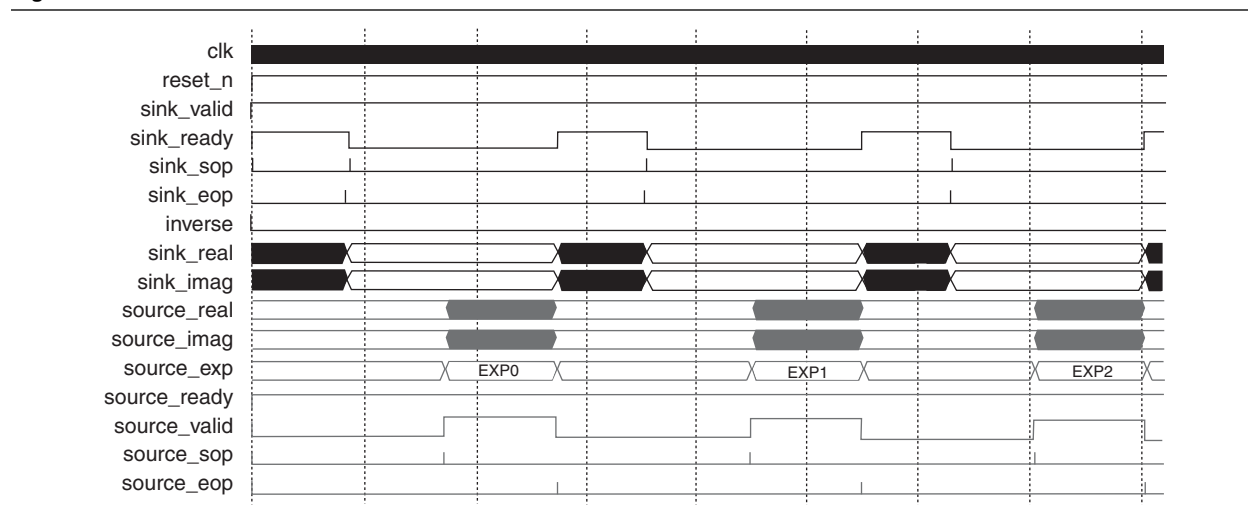

In a burst I/O data flow architecture, the core can process a single input block only. There is a small FIFO buffer at the sink of the block and `sink_ready` is not deasserted until this FIFO buffer is full. Thus you can provide a small number of additional input samples associated with the subsequent input block. It is not mandatory to provide data to the FFT during `sink_ready` cycles. The burst architecture can load the rest of the subsequent FFT frame only when the previous transform has been fully unloaded.

 For information about enabling the buffered burst FFT, refer to “[Enabling the Streaming FFT](#)” on page 3-8.

Parameters

Table 3-3 lists the FFT MegaCore function's parameters.

Table 3-3. Parameters (Part 1 of 3)

Parameter	Value	Description
Target Device Family	<device family>	Displays the target device family. The device family is normally preselected by the project specified in the Quartus II software. The generated HDL for your MegaCore function variation may be incorrect if this value does not match the value specified in the Quartus II project. The device family must be the same as your Quartus II project device family.
Transform Length	64, 128, 256, 512, 1024, 2048, 4096, 8192, 16384, 32768, or 65536. Variable streaming also allows 8, 16, 32, 131072, and 262144.	The transform length. For variable streaming, this value is the maximum FFT length.
Data Precision	8, 10, 12, 14, 16, 18, 20, 24, 28, 32	The data precision. The values 28 and 32 are available for variable streaming only.
Twiddle Precision	8, 10, 12, 14, 16, 18, 20, 24, 28, 32	The twiddle precision. The values 28 and 32 are available for variable streaming only. Twiddle factor precision must be less than or equal to data precision.
FFT Engine Architecture	Quad Output, Single Output	For both the Buffered Burst and Burst I/O data flow architectures, you can choose between one, two, and four quad-output FFT engines working in parallel. Alternatively, if you have selected a single-output FFT engine architecture, you may choose to implement one or two engines in parallel. Multiple parallel engines reduce the FFT MegaCore function's transform time at the expense of device resources—which allows you to select the desired area and throughput trade-off point. For more information about device resource and transform time trade-offs, refer to “Parameters” on page 3-14. Not available for variable streaming or streaming architecture.
Number of Parallel FFT Engines	1, 2, 4	
I/O Data Flow	Streaming Variable Streaming Buffered Burst Burst	Choose the FFT architecture.
I/O Order	Bit Reverse Order, Digit Reverse Order, Natural Order, $-N/2$ to $N/2$	The input and output order for data entering and leaving the FFT (variable streaming architecture only). The Digit Reverse Order option replaces the Bit Reverse Order in variable streaming floating point variations.
Data Representation	Fixed Point or Floating Point	The internal data representation type (variable streaming architecture only), either fixed point with natural bit-growth or single precision floating point.

Table 3-3. Parameters (Part 2 of 3)

Parameter	Value	Description
Structure	3 Mults/5 Adders 4 Mults/2 Adders	You can implement the complex multiplier structure with four real multipliers and two adders/subtractors, or three multipliers, five adders, and some additional delay elements. The 4 Mults/2 Adders structure uses the DSP block structures to minimize logic usage, and maximize the DSP block usage. This option may also improve the push button f_{MAX} . The 5 Mults/3 Adders structure requires fewer DSP blocks, but more LEs to implement. It may also produce a design with a lower f_{MAX} . Not available for variable streaming architecture or in Arria V, Cyclone V, and Stratix V devices.
Implement Multipliers in	DSP Blocks/Logic Cells Logic Cells Only DSP Blocks Only	Each real multiplication can be implemented in DSP blocks or LEs only, or using a combination of both. If you use a combination of DSP blocks and LEs, the FFT MegaCore function automatically extends the DSP block 18×18 multiplier resources with LEs as needed. Not available for variable streaming architecture or in Arria V, Cyclone V, and Stratix V devices.
DSP Resource Optimization	On or Off	This option is available in Stratix V devices for all architectures and representations. You can turn on this option to implement the complex multiplier structure using Stratix V DSP block complex 18×25 multiplication mode or complex 27×27 multiplication mode for better DSP resource utilization, at the possible expense of speed. In the variable streaming architecture using the floating point representation, this option implements the complex multiplier structure using Stratix V DSP block complex 27×27 multiplication mode at the possible expense of accuracy.
Global clock enable	On or Off	Turn on if you want to add a global clock enable to your design.
Twiddle ROM Distribution	100% M4K to 100% M512 or 100% M9K to 100% MLAB	High-throughput FFT parameterizations can require multiple shallow ROMs for twiddle factor storage. If your target device family supports M512 RAM blocks (or MLAB blocks in Stratix III, Stratix IV, and Stratix V devices), you can choose to distribute the ROM storage requirement between M4K (M9K in Stratix III and Stratix IV devices) RAM and M512 (MLAB) RAM blocks by adjusting the slider bar. Set the slider bar to the far left to implement the ROM storage completely in M4K (M9K) RAM blocks; set the slider bar to the far right to implement the ROM completely in M512 (MLAB) RAM blocks. In Stratix V devices, replace M4K (M9K) with M20K memory blocks. Implementing twiddle ROM in M512 (MLAB) RAM blocks can lead to a more efficient device internal memory bit usage. Alternatively, this option can be used to conserve M4K (M9K) RAM blocks used for the storage of FFT data or other storage requirements in your system. Not available for variable streaming architecture or in the Cyclone series of device families.

Table 3-3. Parameters (Part 3 of 3)

Parameter	Value	Description
Use M-RAM or M144K blocks	On or Off	Implements suitable data RAM blocks within the FFT MegaCore function in M-RAM (M144K in Stratix III and Stratix IV devices) to reduce M4K (M9K) RAM block usage, in device families that support M-RAM blocks. Not available for variable streaming architecture, or in the Cyclone series of device families, or in Stratix V devices.
Implement appropriate logic functions in RAM	On or Off	Uses embedded RAM blocks to implement internal logic functions, for example, tapped delay lines in the FFT MegaCore function. This option reduces the overall logic element count. Not available for variable streaming architecture.

Signals

Table 3-4 lists the Avalon-ST interface signals.

 For more information about the Avalon-ST interface, refer to the [Avalon Streaming Interface Specification](#).

Table 3-4. Avalon-ST Signals (Part 1 of 2)

Signal Name	Direction	Avalon-ST Type	Size	Description
clk	Input	clk	1	Clock signal that clocks all internal FFT engine components.
reset_n	Input	reset_n	1	Active-low asynchronous reset signal. This signal can be asserted asynchronously, but must remain asserted at least one clk clock cycle and must be deasserted synchronously with clk. Refer to the Recommended Design Practices chapter in volume 1 of the <i>Quartus II Handbook</i> for a sample circuit that ensures synchronous deassertion of an active-low reset signal.
sink_eop	Input	endofpacket	1	Indicates the end of the incoming FFT frame.
sink_error	Input	error	2	Indicates an error has occurred in an upstream module, because of an illegal usage of the Avalon-ST protocol. The following errors are defined (refer to Table 3-6): <ul style="list-style-type: none"> ■ 00 = no error ■ 01 = missing start of packet (SOP) ■ 10 = missing end of packet (EOP) ■ 11 = unexpected EOP If this signal is not used in upstream modules, set to zero.
sink_imag	Input	data	<i>data precision width</i>	Imaginary input data, which represents a signed number of data precision bits.

Table 3-4. Avalon-ST Signals (Part 2 of 2)

Signal Name	Direction	Avalon-ST Type	Size	Description
sink_ready	Output	ready	1	Asserted by the FFT engine when it can accept data. It is not mandatory to provide data to the FFT during ready cycles.
sink_real	Input	data	<i>data precision width</i>	Real input data, which represents a signed number of data precision bits.
sink_sop	Input	startofpacket	1	Indicates the start of the incoming FFT frame.
sink_valid	Input	valid	1	Asserted when data on the data bus is valid. When <code>sink_valid</code> and <code>sink_ready</code> are asserted, a data transfer takes place. Refer to “Enabling the Variable Streaming FFT” on page 3-9.
source_eop	Output	endofpacket	1	Marks the end of the outgoing FFT frame. Only valid when <code>source_valid</code> is asserted.
source_error	Output	error	2	Indicates an error has occurred either in an upstream module or within the FFT module (logical OR of <code>sink_error</code> with errors generated in the FFT). Refer to Table 3-6 for error codes.
source_exp	Output	data	6	Streaming, burst, and buffered burst architectures only. Signed block exponent: Accounts for scaling of internal signal values during FFT computation.
source_imag	Output	data	<i>(data precision width + growth)⁽¹⁾</i>	Imaginary output data. For burst, buffered burst, streaming, and variable streaming floating point FFTs, the output data width is equal to the input data width. For variable streaming fixed point FFTs, the size of the output data is dependent on the number of stages defined for the FFT and is 2 bits per radix 2 ² stage.
source_ready	Input	ready	1	Asserted by the downstream module if it is able to accept data.
source_real	Output	data	<i>(data precision width + growth)⁽¹⁾</i>	Real output data. For burst, buffered burst, streaming, and variable streaming floating point FFTs, the output data width is equal to the input data width. For variable streaming fixed point FFTs, the size of the output data is dependent on the number of stages defined for the FFT and is 2 bits per radix 2 ² stage.
source_sop	Output	startofpacket	1	Marks the start of the outgoing FFT frame. Only valid when <code>source_valid</code> is asserted.
source_valid	Output	valid	1	Asserted by the FFT when there is valid data to output.

Note to Table 3-4:

(1) Variable streaming fixed point FFT only. Growth is $\log_2(N) + 1$.

Table 3-5 shows the component specific signals.

Table 3-5. Component Specific Signals

Signal Name	Direction	Size	Description
fftps_in	Input	$\log_2(\text{maximum number of points})$	The number of points in this FFT frame. If this value is not specified, the FFT can not be a variable length. The default behavior is for the FFT to have fixed length of maximum points. Only sampled at SOP.
fftps_out	Output	$\log_2(\text{maximum number of points})$	The number of points in this FFT frame synchronized to the Avalon-ST source interface. Variable streaming only.
inverse	Input	1	Inverse FFT calculated if asserted. Only sampled at SOP.
clk_ena	Input	1	Active-high global clock enable input. If deasserted, the FFT is disabled.

Incorrect usage of the Avalon-ST interface protocol on the sink interface results in an error on `source_error`. Table 3-6 defines the behavior of the FFT when an incorrect Avalon-ST transfer is detected. If an error occurs, the behavior of the FFT is undefined and you must reset the FFT with `reset_n`.

Table 3-6. Error Handling Behavior

Error	source_error	Description
Missing SOP	01	Asserted when valid goes high, but there is no start of frame.
Missing EOP	10	Asserted if the FFT accepts <i>N</i> valid samples of an FFT frame, but there is no EOP signal.
Unexpected EOP	11	Asserted if EOP is asserted before <i>N</i> valid samples are accepted.

Introduction

The FFT MegaCore function uses block-floating-point (BFP) arithmetic internally to perform calculations. BFP architecture is a trade-off between fixed-point and full floating-point architecture.

Unlike an FFT block that uses floating point arithmetic, a block-floating-point FFT block does not provide an input for exponents. Internally, a complex value integer pair is represented with a single scale factor that is typically shared among other complex value integer pairs. After each stage of the FFT, the largest output value is detected and the intermediate result is scaled to improve the precision. The exponent records the number of left or right shifts used to perform the scaling. As a result, the output magnitude relative to the input level is:

$$\text{output} * 2^{-\text{exponent}}$$

For example, if $\text{exponent} = -3$, the input samples are shifted right by three bits, and hence the magnitude of the output is $\text{output} * 2^3$.

Block Floating Point

After every pass through a radix-2 or radix-4 engine in the FFT core, the addition and multiplication operations cause the data bits width to grow. In other words, the total data bits width from the FFT operation grows proportionally to the number of passes. The number of passes of the FFT/IFFT computation depends on the logarithm of the number of points. [Table 4-1 on page 4-2](#) shows the possible exponents for corresponding bit growth.

A fixed-point architecture FFT needs a huge multiplier and memory block to accommodate the large bit width growth to represent the high dynamic range. Though floating-point is powerful in arithmetic operations, its power comes at the cost of higher design complexity such as a floating-point multiplier and a floating-point adder. BFP arithmetic combines the advantages of floating-point and fixed-point arithmetic. BFP arithmetic offers a better signal-to-noise ratio (SNR) and dynamic range than does floating-point and fixed-point arithmetic with the same number of bits in the hardware implementation.

In a block-floating-point architecture FFT, the radix-2 or radix-4 computation of each pass shares the same hardware, with the data being read from memory, passed through the core engine, and written back to memory. Before entering the next pass, each data sample is shifted right (an operation called "scaling") if there is a carry-out bit from the addition and multiplication operations. The number of bits shifted is based on the difference in bit growth between the data sample and the maximum data sample detected in the previous stage. The maximum bit growth is recorded in the exponent register. Each data sample now shares the same exponent value and data bit width to go to the next core engine. The same core engine can be reused without incurring the expense of a larger engine to accommodate the bit growth.

The output SNR depends on how many bits of right shift occur and at what stages of the radix core computation they occur. In other words, the signal-to-noise ratio is data dependent and you need to know the input signal to compute the SNR.

Calculating Possible Exponent Values

Depending on the length of the FFT/IFFT, the number of passes through the radix engine is known and therefore the range of the exponent is known. The possible values of the exponent are determined by the following equations:

$$P = \text{ceil}\{\log_4 N\}, \text{ where } N \text{ is the transform length}$$

$$R = 0 \text{ if } \log_2 N \text{ is even, otherwise } R = 1$$

$$\text{Single output range} = (-3P+R, P+R-4)$$

$$\text{Quad output range} = (-3P+R+1, P+R-7)$$

These equations translate to the values in [Table 4-1](#).

Table 4-1. Exponent Scaling Values for FFT / IFFT ⁽¹⁾

N	P	Single Output Engine		Quad Output Engine	
		Max ⁽²⁾	Min ⁽²⁾	Max ⁽²⁾	Min ⁽²⁾
64	3	-9	-1	-8	-4
128	4	-11	1	-10	-2
256	4	-12	0	-11	-3
512	5	-14	2	-13	-1
1,024	5	-15	1	-14	-2
2,048	6	-17	3	-16	0
4,096	6	-18	2	-17	-1
8,192	7	-20	4	-19	1
16,384	7	-21	3	-20	0

Note to Table 4-1:

- (1) This table lists the range of exponents, which is the number of scale events that occurred internally. For IFFT, the output must be divided by N externally. If more arithmetic operations are performed after this step, the division by N must be performed at the end to prevent loss of precision.
- (2) The maximum and minimum values show the number of times the data is shifted. A negative value indicates shifts to the left, while a positive value indicates shifts to the right.

Implementing Scaling

To implement the scaling algorithm, follow these steps:

1. Determine the length of the resulting full scale dynamic range storage register. To get the length, add the width of the data to the number of times the data is shifted (the max value in [Table 4-1](#)). For example, for a 16-bit data, 256-point Quad Output FFT/IFFT with Max = -11 and Min = -3. The Max value indicates 11 shifts to the left, so the resulting full scaled data width is 16 + 11, or 27 bits.

2. Map the output data to the appropriate location within the expanded dynamic range register based upon the exponent value. To continue the above example, the 16-bit output data [15..0] from the FFT/IFFT is mapped to [26..11] for an exponent of -11, to [25..10] for an exponent of -10, to [24..9] for an exponent of -9, and so on.
3. Sign extend the data within the full scale register.

A sample of Verilog HDL code that illustrates the scaling of the output data (for exponents -11 to -9) with sign extension is shown in the following example:

```

case (exp)
  6'b110101 : //-11 Set data equal to MSBs
    begin
      full_range_real_out[26:0] <= {real_in[15:0],11'b0};
      full_range_imag_out[26:0] <= {imag_in[15:0],11'b0};
    end
  6'b110110 : //-10 Equals left shift by 10 with sign extension
    begin
      full_range_real_out[26] <= {real_in[15]};
      full_range_real_out[25:0] <= {real_in[15:0],10'b0};
      full_range_imag_out[26] <= {imag_in[15]};
      full_range_imag_out[25:0] <= {imag_in[15:0],10'b0};
    end
  6'b110111 : //-9 Equals left shift by 9 with sign extension
    begin
      full_range_real_out[26:25] <= {real_in[15],real_in[15]};
      full_range_real_out[24:0] <= {real_in[15:0],9'b0};
      full_range_imag_out[26:25] <= {imag_in[15],imag_in[15]};
      full_range_imag_out[24:0] <= {imag_in[15:0],9'b0};
    end
  .
  .
  .
endcase

```

In this example, the output provides a full scale 27-bit word. You must choose how many and which bits must be carried forward in the processing chain. The choice of bits determines the absolute gain relative to the input sample level.

Figure 4-1 on page 4-4 demonstrates the effect of scaling for all possible values for the 256-point quad output FFT with an input signal level of 0x5000. The output of the FFT is 0x280 when the exponent = -5. The figure illustrates all cases of valid exponent values of scaling to the full scale storage register [26..0]. Because the exponent is -5, you must check the register values for that column. This data is shown in the last two columns in the figure. Note that the last column represents the gain compensated data after the scaling (0x0005000), which agrees with the input data as expected. If you want to keep 16 bits for subsequent processing, you can choose the bottom 16 bits that result in 0x5000. However, if you choose a different bit range, such as the top 16 bits, the result is 0x000A. Therefore, the choice of bits affects the relative gain through the processing chain.

Because this example has 27 bits of full scale resolution and 16 bits of output resolution, choose the bottom 16 bits to maintain unity gain relative to the input signal. Choosing the LSBs is not the only solution or the correct one for all cases. The choice depends on which signal levels are important. One way to empirically select the proper range is by simulating test cases that implement expected system data. The output of the simulations must tell what range of bits to use as the output register. If the full scale data is not used (or just the MSBs), you must saturate the data to avoid wraparound problems.

Figure 4-1. Scaling of Input Data Sample = 0x5000

Bit	Input	Output Data	Exponent											Looking at Exponent = -5		
			-11	-10	-9	-8	-7	-6	-5	-4	-3	Taking All Bits	Sign Extend / Pad			
	5000 H	280 H														
26			0													0
25			0	0												0
24			0	0	0											0
23			0	0	0	0										0
22			0	0	0	0	0									0
21			0	0	0	0	0	0								0
20			1	0	0	0	0	0	0	0					0	0
19			0	1	0	0	0	0	0	0	0				0	0
18			1	0	1	0	0	0	0	0	0	0			0	0
17			0	1	0	1	0	0	0	0	0	0	0		0	0
16			0	0	1	0	1	0	0	0	0	0	0		0	0
15	0	0	0	0	0	1	0	1	0	1	0	0	0		0	0
14	1	0	0	0	0	0	0	1	0	1	0	0	0		1	1
13	0	0	0	0	0	0	0	0	1	0	1	0	0		0	0
12	1	0	0	0	0	0	0	0	0	1	0	1	0		1	1
11	0	0	0	0	0	0	0	0	0	0	1	0	0		0	0
10	0	0	0	0	0	0	0	0	0	0	0	1	0		0	0
9	0	1	0	0	0	0	0	0	0	0	0	0	0		0	0
8	0	0	0	0	0	0	0	0	0	0	0	0	0		0	0
7	0	1	0	0	0	0	0	0	0	0	0	0	0		0	0
6	0	0	0	0	0	0	0	0	0	0	0	0	0		0	0
5	0	0	0	0	0	0	0	0	0	0	0	0	0		0	0
4	0	0	0	0	0	0	0	0	0	0	0	0	0		0	0
3	0	0	0	0	0	0	0	0	0	0	0	0	0		0	0
2	0	0	0	0	0	0	0	0	0	0	0	0	0		0	0
1	0	0	0	0	0	0	0	0	0	0	0	0	0		0	0
0	0	0	0	0	0	0	0	0	0	0	0	0	0		0	0

Achieving Unity Gain in an IFFT+FFT Pair

Given sufficiently high precision, such as with floating-point arithmetic, it is theoretically possible to obtain unity gain when an IFFT and FFT are cascaded. However, in BFP arithmetic, special attention must be paid to the exponent values of the IFFT/FFT blocks to achieve the unity gain. This section explains the steps required to derive a unity gain output from an Altera IFFT/FFT MegaCore pair, using BFP arithmetic.

Because BFP arithmetic does not provide an input for the exponent, you must keep track of the exponent from the IFFT block if you are feeding the output to the FFT block immediately thereafter and divide by *N* at the end to acquire the original signal magnitude.

Figure 4–2 on page 4–5 shows the operation of IFFT followed by FFT and derives the equation to achieve unity gain.

Figure 4–2. Derivation to Achieve IFFT/FFT Pair Unity Gain

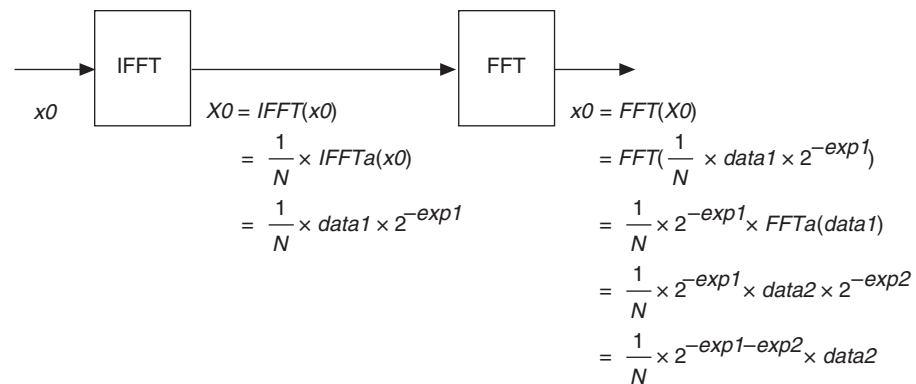

where:

$x0$ = Input data to IFFT

$X0$ = Output data from IFFT

N = number of points

data1 = IFFT output data and FFT input data

data2 = FFT output data

exp1 = IFFT output exponent

exp2 = FFT output exponent

IFFTa = IFFT

FFTa = FFT

Any scaling operation on $X0$ followed by truncation loses the value of exp1 and does not result in unity gain at $x0$. Any scaling operation must be done on $X0$ only when it is the final result. If the intermediate result $X0$ is first padded with exp1 number of zeros and then truncated or if the data bits of $X0$ are truncated, the scaling information is lost.

One way to keep unity gain is by passing the exp1 value to the output of the FFT block. The other way is to preserve the full precision of $\text{data1} \times 2^{-\text{exp1}}$ and use this value as input to the FFT block. The disadvantage of the second method is a large size requirement for the FFT to accept the input with growing bit width from IFFT operations. The resolution required to accommodate this bit width will, in most cases, exceed the maximum data width supported by the core.

 For more information, refer to the *Achieving Unity Gain in Block Floating Point IFFT+FFT Pair* design example under DSP Design Examples at www.altera.com.

This chapter provides additional information about the document and Altera.

Revision History

The following table shows the revision history for this user guide.

Date	Version	Changes Made
November 2011	11.1	<ul style="list-style-type: none"> ■ Updated Table 1–1. ■ Added Arria V and Cyclone V device support in Table 1–3. ■ Added Stratix V in the “Performance and Resource Utilization” section. ■ Updated Table 3–3 to include 8-point FFT.
May 2011	11.0	<ul style="list-style-type: none"> ■ Added user-controlled parameter for DSP resource optimization in Stratix V devices. ■ Changed device support level from Preliminary to Final for Arria II GX, Arria II GZ, Cyclone III LS, and Cyclone IV devices. ■ Changed device support level from HardCopy Companion to HardCopy Compilation for HardCopy III E, HardCopy IV E, and HardCopy IV GX devices.
December 2010	10.1	<ul style="list-style-type: none"> ■ Added preliminary support for Arria II GZ devices. ■ Updated support level to final support for Stratix IV GT devices.
July 2010	10.0	<ul style="list-style-type: none"> ■ Added preliminary support for Stratix V devices. ■ Added new Transform Length values.
November 2009	9.1	<ul style="list-style-type: none"> ■ Maintenance update. ■ Added preliminary support for Cyclone III LS, Cyclone IV, and HardCopy IV GX devices.
March 2009	9.0	Added Arria II GX device support.
November 2008	8.1	No changes.
May 2008	8.0	<ul style="list-style-type: none"> ■ Added Stratix IV device support. ■ Changed descriptions of the behavior of <code>sink_valid</code> and <code>sink_ready</code>.
October 2007	7.2	<ul style="list-style-type: none"> ■ Corrected timing diagrams. ■ Added single precision floating point data representation information.
May 2007	7.1	<ul style="list-style-type: none"> ■ Added support for Arria GX devices. ■ Added new generated files.
December 2006	7.0	Added support for Cyclone III devices.
December 2006	6.1	<ul style="list-style-type: none"> ■ Changed interface information. ■ Added variable streaming information.

To locate the most up-to-date information about Altera products, refer to the following table.





<i>(1)</i>		
Technical support	Website	www.altera.com/support
Technical training	Website	www.altera.com/training
	Email	custrain@altera.com
Product literature	Website	www.altera.com/literature
Nontechnical support (general) (software licensing)	Email	nacomp@altera.com
	Email	authorization@altera.com

Note to Table:

(1) You can also contact your local Altera sales office or sales representative.

The following table shows the typographic conventions this document uses.

Bold Type with Initial Capital Letters	Indicate command names, dialog box titles, dialog box options, and other GUI labels. For example, Save As dialog box. For GUI elements, capitalization matches the GUI.
bold type	Indicates directory names, project names, disk drive names, file names, file name extensions, software utility names, and GUI labels. For example, \qdesigns directory, D: drive, and chiptrip.gdf file.
<i>Italic Type with Initial Capital Letters</i>	Indicate document titles. For example, <i>Stratix IV Design Guidelines</i> .
<i>italic type</i>	Indicates variables. For example, $n + 1$. Variable names are enclosed in angle brackets (< >). For example, <file name> and <project name>.pdf file.
Initial Capital Letters	Indicate keyboard keys and menu names. For example, the Delete key and the Options menu.
“Subheading Title”	Quotation marks indicate references to sections in a document and titles of Quartus II Help topics. For example, “Typographic Conventions.”
Courier type	Indicates signal, port, register, bit, block, and primitive names. For example, data1, tdi, and input. The suffix n denotes an active-low signal. For example, resetn. Indicates command line commands and anything that must be typed exactly as it appears. For example, c:\qdesigns\tutorial\chiptrip.gdf. Also indicates sections of an actual file, such as a Report File, references to parts of files (for example, the AHDL keyword SUBDESIGN), and logic function names (for example, TRI).
↵	An angled arrow instructs you to press the Enter key.
1., 2., 3., and a., b., c., and so on	Numbered steps indicate a list of items when the sequence of the items is important, such as the steps listed in a procedure.
■ ■ ■	Bullets indicate a list of items when the sequence of the items is not important.
	The hand points to information that requires special attention.

	The question mark directs you to a software help system with related information.
	The feet direct you to another document or website with related information.
	The multimedia icon directs you to a related multimedia presentation.
	A caution calls attention to a condition or possible situation that can damage or destroy the product or your work.
	A warning calls attention to a condition or possible situation that can cause you injury.
	The envelope links to the Email Subscription Management Center page of the Altera website, where you can sign up to receive update notifications for Altera documents.

