

ByteBlasterMV Download Cable User Guide



101 Innovation Drive
San Jose, CA 95134
(408) 544-7000
<http://www.altera.com>

P25-10323-00

Document Version:
Document Date:

1.0
July 2004

Copyright © 2004 Altera Corporation. All rights reserved. Altera, The Programmable Solutions Company, the stylized Altera logo, specific device designations, and all other words and logos that are identified as trademarks and/or service marks are, unless noted otherwise, the trademarks and service marks of Altera Corporation in the U.S. and other countries. All other product or service names are the property of their respective holders. Altera products are protected under numerous U.S. and foreign patents and pending applications, maskwork rights, and copyrights. Altera warrants performance of its semiconductor products to current specifications in accordance with Altera's standard warranty, but reserves the right to make changes to any products and services at any time without notice. Altera assumes no responsibility or liability arising out of the application or use of any information, product, or service described herein except as expressly agreed to in writing by Altera Corporation. Altera customers are advised to obtain the latest version of device specifications before relying on any published information and before placing orders for products or services.



Printed on recycled paper



I.S. EN ISO 9001



| | |
|--|----------|
| About this User Guide | v |
| Revision History | v |
| How to Find Information | v |
| How to Contact Altera | v |
| Typographic Conventions | vi |
| Abbreviations & Acronyms | vii |
| | |
| Chapter 1. Installing the ByteBlasterMV Download Cable | |
| Introduction | 1-1 |
| Installation | 1-1 |
| Installation on a Windows PC | 1-1 |
| Installing the Altera ByteBlaster Driver with the BBLPT Utility | 1-2 |
| Installing the Altera ByteBlaster Driver on Windows NT | 1-2 |
| Installing the Altera ByteBlaster Driver on Windows 2000 | 1-3 |
| Installing the Altera ByteBlaster Driver on Windows XP | 1-4 |
| Installing the ByteBlasterMV Download Cable | 1-6 |
| Installation on a Linux Workstation | 1-7 |
| Installing the Altera ByteBlaster Kernel Driver for Linux | 1-7 |
| Installing the ByteBlasterMV Download Cable on a Linux Workstation | 1-8 |
| Selecting a Communications Cable for the SignalTap II Logic Analyzer | 1-9 |
| | |
| Chapter 2. ByteBlasterMV Download Cable Data Sheet | |
| Features | 2-1 |
| Functional Description | 2-1 |
| Download Modes | 2-1 |
| ByteBlasterMV Connections | 2-2 |
| ByteBlasterMV Header & Plug Connections | 2-3 |
| Circuit Board Header Connection | 2-4 |
| Operating Conditions | 2-5 |
| Software Instructions | 2-6 |
| Conclusion | 2-7 |
| References | 2-7 |



About this User Guide

Revision History

The table below shows this user guide's revision history.

| <i>ByteBlasterMV Download Cable User Guide Revision History</i> | |
|---|-----------------|
| Date | Description |
| July 2004 | Initial release |

How to Find Information

You can find more information in the following ways:

- The Adobe Acrobat Find feature, which searches the text of a PDF document. Click the binoculars toolbar icon to open the Find dialog box.
- Acrobat bookmarks, which serve as an additional table of contents in PDF documents.
- Thumbnail icons, which provide miniature previews of each page, provide a link to the pages.
- Numerous links, shown in green text, which allow you to jump to related information.

How to Contact Altera

For the most up-to-date information about Altera products, go to the Altera world-wide web site at www.altera.com. For technical support on this product, go to www.altera.com/mysupport. For additional information about Altera products, consult the sources shown below.





| Information Type | USA & Canada | All Other Locations |
|--------------------------------|--|--|
| Technical support | www.altera.com/mysupport/ | www.altera.com/mysupport/ |
| | (800) 800-EPLD (3753) (7:00 a.m. to 5:00 p.m. Pacific Time) | (408) 544-7000 (1) (7:00 a.m. to 5:00 p.m. Pacific Time) |
| Product literature | www.altera.com | www.altera.com |
| Altera literature services | lit_req@altera.com (1) | lit_req@altera.com (1) |
| Non-technical customer service | (800) 767-3753 | (408) 544-7000 (7:30 a.m. to 5:30 p.m. Pacific Time) |
| FTP site | ftp.altera.com | ftp.altera.com |

Note to table:

(1) You can also contact your local Altera sales office or sales representative.

Typographic Conventions

This document uses the typographic conventions shown below.

| Visual Cue | Meaning |
|---|--|
| Bold Type with Initial Capital Letters | Command names, dialog box titles, checkbox options, and dialog box options are shown in bold, initial capital letters. Example: Save As dialog box. |
| bold type | External timing parameters, directory names, project names, disk drive names, filenames, filename extensions, and software utility names are shown in bold type. Examples: f_{MAX} , qdesigns directory, d: drive, chiptrip.gdf file. |
| <i>Italic Type with Initial Capital Letters</i> | Document titles are shown in italic type with initial capital letters. Example: <i>AN 75: High-Speed Board Design</i> . |
| <i>Italic type</i> | Internal timing parameters and variables are shown in italic type. Examples: <i>t_{PIA}</i> , <i>n + 1</i> . Variable names are enclosed in angle brackets (< >) and shown in italic type. Example: <file name>, <project name>.pof file. |
| Initial Capital Letters | Keyboard keys and menu names are shown with initial capital letters. Examples: Delete key, the Options menu. |
| “Subheading Title” | References to sections within a document and titles of on-line help topics are shown in quotation marks. Example: “Typographic Conventions.” |
| Courier type | Signal and port names are shown in lowercase Courier type. Examples: data1, tdi, input. Active-low signals are denoted by suffix n, e.g., resetn. Anything that must be typed exactly as it appears is shown in Courier type. For example: c:\qdesigns\tutorial\chiptrip.gdf. Also, sections of an actual file, such as a Report File, references to parts of files (e.g., the AHDL keyword SUBDESIGN), as well as logic function names (e.g., TRI) are shown in Courier. |
| 1., 2., 3., and a., b., c., etc. | Numbered steps are used in a list of items when the sequence of the items is important, such as the steps listed in a procedure. |
|  | Bullets are used in a list of items when the sequence of the items is not important. |
|  | The checkmark indicates a procedure that consists of one step only. |
|  | The hand points to information that requires special attention. |
|  | The angled arrow indicates you should press the Enter key. |
|  | The feet direct you to more information on a particular topic. |

Abbreviations & Acronyms

The following abbreviations and acronyms are used in this document.

| Acronym | Meaning |
|---------|--------------------------------------|
| AHDL | Altera hardware description language |
| APU | Altera Programming Unit |
| CPU | central processing unit |
| EDA | electronic design automation |
| IP | intellectual property |
| LE | logic element |



1. Installing the ByteBlasterMV Download Cable

Introduction

You can use the ByteBlasterMV™ download cable to do the following:

- Download configuration data to SRAM-based devices, such as Stratix® II, Stratix GX, Stratix, Cyclone™ II Cyclone, APEX™ II, APEX 20K (including APEX 20K, APEX 20KE, and APEX 20KC), ACEX® 1K, Mercury™, FLEX® 10K (including FLEX 10KA and FLEX 10KE), FLEX 8000, FLEX 6000, and Excalibur™ devices.
- Download configuration data to EEPROM-based devices, such as MAX® II, MAX 9000, MAX 7000S, MAX 7000AE, MAX 7000B, and MAX 3000A
- Perform in-system programming of advanced configuration (EPC2, EPC4, EPC8, and EPC16)
- Perform SignalTap II logic analysis
- Connect the ByteBlasterMV download cable directly to your PC's parallel port, a Linux workstation parallel port, or through an Altera Software Guard that is connected to the parallel port.

Installation

The ByteBlasterMV download cable has a 25-pin male header that connects to the PC parallel port, and a 10-pin female plug that connects to the circuit board. Data is downloaded from the PC's parallel port through the ByteBlasterMV cable to the circuit board via these connections.

This section explains the following procedures:

- Installing the Altera ByteBlaster™ driver with the BBLPT Utility
- Installing the Altera ByteBlaster driver on Windows NT
- Installing the Altera ByteBlaster driver on Windows 2000
- Installing the Altera ByteBlaster driver on Windows XP
- Installing the ByteBlasterMV download cable

Installation on a Windows PC

To install the ByteBlasterMV download cable on a Windows PC, you must perform the following steps, each of which are described in more detail in this section.

- Install the Altera ByteBlaster driver
- Install the ByteBlasterMV download cable

Installing the Altera ByteBlaster Driver with the BBLPT Utility

The Altera ByteBlaster driver can be installed or removed with the **BBLPT** utility. You can use the **BBLPT** utility with Windows NT, Windows 2000, and Windows XP. You must install the Altera ByteBlaster driver separately from the Quartus® II software.

 You do not need to install the ByteBlasterMV download cable before installing the Altera ByteBlaster kernel driver, and this installation requires that you have administration (administrator) privileges.

To install the Altera ByteBlaster driver with the **BBLPT** utility, follow this step:

- ✓ From the `\<Quartus II system directory>\drivers\i386` directory, type the following command at the command prompt:

```
bb1pt /i ←
```

To remove the Altera ByteBlaster driver with the **BBLPT** utility, follow this step:

- ✓ From the `\<Quartus II system directory>\drivers\i386` directory, type the following command at the command prompt:

```
bb1pt /r ←
```

Installing the Altera ByteBlaster Driver on Windows NT

The Altera ByteBlaster driver is required for PCs running Windows NT 4.0 that use the ByteBlasterMV download cable. You must install the Altera ByteBlaster driver separately from the Quartus II software.

 You do not need to install the ByteBlasterMV download cable before installing the Altera ByteBlaster kernel driver, and this installation requires that you have administration (administrator) privileges.

To install the Altera ByteBlaster driver for Windows NT, follow these steps:

 You can also use the **BBLPT** utility to install the Altera ByteBlaster driver.



For more information, go to [“Installing the Altera ByteBlaster Driver with the BBLPT Utility”](#) on page 1–2.

1. Choose **Settings > Control Panel** (Windows Start menu).
2. In the Control Panel window, double-click the **Multimedia** icon.

3. In the **Multimedia Properties** dialog box, click the **Devices** tab, and click **Add**.
4. In the **List of Drivers** list, select **Unlisted or Updated Driver** and click **OK**.
5. In the **Install Driver** dialog box, type `<disk drive>: \<Quartus II system directory>\drivers` or select the name with **Browse (...)** to specify the Quartus II software **drivers** directory.
6. Click **OK**.
7. In the **Add Unlisted or Updated Driver** dialog box, select **Altera ByteBlaster**.
8. To restart your computer, click **Restart Now**.

Installing the Altera ByteBlaster Driver on Windows 2000

The Altera ByteBlaster driver is required for PCs running Windows 2000 that use the ByteBlasterMV download cable. You must install the Altera ByteBlaster driver separately from the Quartus II software.



You do not need to install the ByteBlasterMV download cable before installing the Altera ByteBlaster kernel driver.



Installing the Altera ByteBlaster kernel driver requires that you have administration (administrator) privileges.

To install the Altera ByteBlaster driver for Windows 2000, follow these steps:



You can also use the **BBLPT** utility to install the Altera ByteBlaster.



For more information, go to [“Installing the Altera ByteBlaster Driver with the BBLPT Utility”](#) on page 1–2.

1. Choose **Settings > Control Panel** (Windows Start menu).
2. In the **Control Panel** window, double-click the **Add/Remove Hardware** icon and click **Next**.
3. In the **Choose a Hardware Task** page of the **Add/Remove Hardware** wizard, select **Add/Troubleshoot a device** and click **Next**.
4. In the **Choose a Hardware Device** page, select **Add a new device** and click **Next**.

5. In the **Find New Hardware** page, select **No, I want to select the hardware from a list** and click **Next**.
6. In the **Hardware Type** page, select **Sound, video and game controllers** and click **Next**.
7. In the **Select a Device Driver** page, select **Have disk**.
8. Specify the full directory path to the \<*Quartus II system directory*>\drivers\win2000 directory with **Browse (...)**, and click **OK**.
9. In the **Digital Signature Not Found** page, click **Yes**.
10. In the **Select a Device Driver** page, select either **ByteBlaster II** or **ByteBlasterMV**, and click **Next**.
11. In the **Start Hardware Installation** page, click **Next**.
12. In the **Digital Signature Not Found** page, click **Yes**.
13. In the **Completing the Add/Remove Hardware Wizard** page, click **Finish**.
14. To restart your computer, click **Restart Now**.

Installing the Altera ByteBlaster Driver on Windows XP

The Altera ByteBlaster driver is required for PCs running Windows XP that use the ByteBlasterMV download cable. You must install the Altera ByteBlaster driver separately from the Quartus II software.

 You do not need to install the ByteBlasterMV download cable before installing the Altera ByteBlaster kernel driver.

 Installing the Altera ByteBlaster kernel driver requires that you have administration (administrator) privileges.

To install the Altera ByteBlaster driver for Windows XP, follow these steps:

 You can also use the **BBLPT** utility to install the Altera ByteBlaster.



For more information, go to “[Installing the Altera ByteBlaster Driver with the BBLPT Utility](#)” on page 1–2.

1. Choose **Control Panel** (Windows Start menu).
2. Click the **Switch to Classic View** link.

3. In the **Control Panel** window, double-click **Add Hardware** and click **Next**. The **Add/Remove Hardware Wizard** dialog box appears.
4. Select **Yes, I have already connected the hardware**, and click **Next**.
5. In the **Installed hardware** list, select **Add a new hardware device** and click **Next**.
6. Select **Install the hardware that I manually select from a list (Advanced)**, and click **Next**.
7. Select **Sound, video and game controllers**, and click **Next**.
8. Select **Have disk**.
9. Specify the full directory path to the *\<Quartus II system directory>\drivers\win2000* directory with **Browse (...)**, and click **OK**.
10. In the **Digital Signature Not Found** page, click **Yes**. A software installation warning appears.
11. Click **Continue Anyway**.
12. Select **Altera ByteBlaster** and click **Next**. A hardware installation warning appears.
13. Click **Continue Anyway**.
14. Click **Finish**.
15. When prompted to restart your computer, click **Yes**.

Installing the ByteBlasterMV Download Cable

To install and set up the ByteBlasterMV parallel port download cable for device configuration or programming, follow these steps:

1. Attach the ByteBlasterMV download cable to a parallel port on your PC and insert the 10-pin female plug into the prototype system containing the target device, as shown in [Figure 1-1](#).



The board must supply power to the ByteBlasterMV download cable.

Figure 1–1. ByteBlasterMV Parallel Port Download Cable

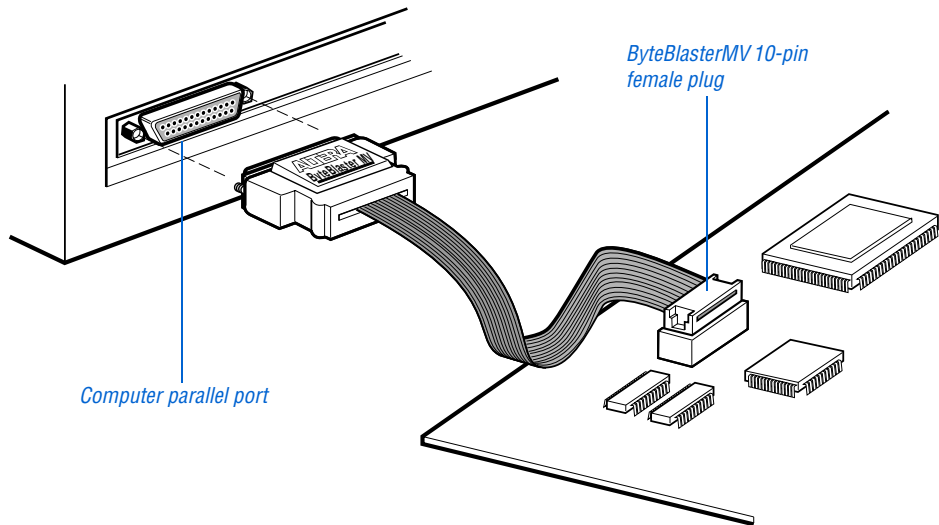

2. Choose **Programmer** (Tools menu).

or

Choose **New** (File menu). Click the **Other Files** tab, select **Chain Description File**, and click **OK**.

3. In the Programmer window, click **Hardware**. The **Hardware Settings** tab of the **Hardware Setup** dialog box is displayed.
4. Click **Add Hardware**. The **Add Hardware** dialog box is displayed.
5. In the **Hardware type** list, select **ByteBlaster II** or **ByteBlasterMV**.
6. In the **Port** list, select the appropriate port.
7. Click **OK**.

Installation on a Linux Workstation

To install the ByteBlasterMV download cable on a Linux workstation, you must perform the following steps, each of which are described in more detail in this section:



- Install the Altera ByteBlaster kernel driver on a Linux workstation running Red Hat Linux versions 7.3 or 8.0, or Red Hat Enterprises Linux version 3.0.
- Install the ByteBlasterMV download cable.

Installing the Altera ByteBlaster Kernel Driver for Linux

The Altera ByteBlaster kernel driver is required for Linux workstations running Red Hat Linux version 7.3 or 8.0, or Red Hat Enterprises Linux version 3.0 that use the ByteBlasterMV download cable. You must install and compile the Altera ByteBlaster kernel driver outside of the Quartus II software.

To compile the Altera ByteBlaster kernel driver, you must have the following Red Hat Package Manager (RPM) packages, which are available from the Red Hat web site at www.redhat.com:

- `.gcc-2.96-81`
- `.make-3.79.1-5`
- `.binutils-2.10.91.0.2-3`
- `kernel-headers` (RPM version must correspond to kernel version)

To verify that an RPM is installed, use the `rpm -q <name>`  command. For example, `rpm -q gcc`  verifies that the `gcc` RPM is installed.



You do not need to install the ByteBlasterMV download cable before installing the Altera ByteBlaster kernel driver.



Installing the Altera ByteBlaster kernel driver requires that you have administration (administrator) privileges.

To install the Altera ByteBlaster kernel driver for Linux workstations, follow these steps:

1. Decompress the `byteblaster.tar.gz` file by typing the following command at the command prompt:

```
tar -xzvf byteblaster.tar.gz 
```

2. Access the new directory by typing the following command at the command prompt:

```
cd byteblaster ↵
```

3. Run the **configure** install script by typing the following command at the command prompt:

```
./configure ↵
```

4. Compile the Altera ByteBlaster kernel driver by typing the following command at the command prompt:

```
make ↵
```

5. Become root and compile the Altera ByteBlaster kernel driver module and device nodes by typing the following command at the command prompt:

```
make install ↵
```

Installing the ByteBlasterMV Download Cable on a Linux Workstation

To install and set up the ByteBlasterMV download cable on a Linux workstation for device configuration or programming, follow these steps:

1. Attach the ByteBlasterMV download cable to a parallel port on your Linux workstation and insert the 10-pin female plug into the prototype system containing the target device, as shown in [Figure 1-2](#).



The board must supply power to the ByteBlasterMV download cable.

Figure 1–2. ByteBlasterMV Parallel Port Download Cable Connections

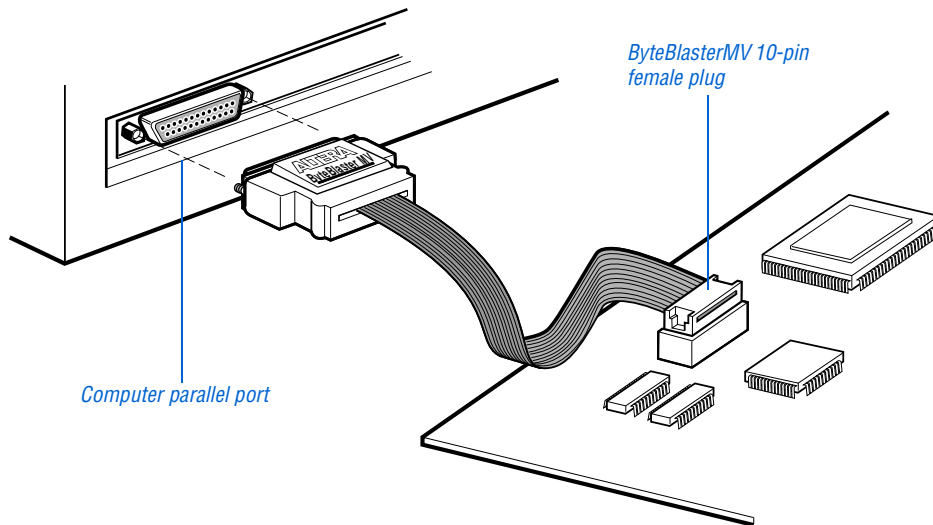

2. To install the Altera ByteBlaster kernel driver, type the following command at the command prompt:

```
jtagconfig --add byteblastermv /dev/byteblaster0 ←
```

3. To determine whether the ByteBlasterMV download cable and the Altera ByteBlaster kernel driver were installed correctly, display a list of available devices by the typing the following commands at the command prompt:

```
jtagconfig ←
```

You should see a list of devices on your JTAG chain, including the ByteBlasterMV download cable.

Selecting a Communications Cable for the SignalTap II Logic Analyzer

To select a communications cable for the SignalTap® II Logic Analyzer, follow these steps.

1. Choose **SignalTap II Logic Analyzer** (Tools menu).

The SignalTap window will open.

2. Under **JTAG Chain Configuration**, select **ByteBlasterMV** in the **Hardware** pulldown list.

If the communications cable that you want to use does not appear in the **Hardware** list, continue as follows:

3. Under **JTAG Chain Configuration**, click **Setup**.
4. Click **Add Hardware** in the **Hardware Setup** dialog box to add a hardware setup for the communications cable.



For more information about SignalTap II logic analysis with the ByteBlasterMV download cable, refer to “Selecting the Communications Cable for the SignalTap II Logic Analyzer” in Quartus II Help.

Ordering code: PL-BYTEBLASTERMV



2. ByteBlasterMV Download Cable Data Sheet

Features

- Allows PC users to perform the following functions:
 - Program MAX[®] II, MAX 9000, MAX 7000S, MAX 7000AE, MAX 7000B, MAX 3000A, advanced configuration (EPC2, EPC4, EPC8, and EPC16)
 - Configure Stratix[®] II, Stratix GX, Stratix, Cyclone[™] II, Cyclone, APEX[™] II, APEX 20K (including APEX 20K, APEX 20KE, and APEX 20KC), ACEX[®] 1K, Mercury[™], FLEX[®] 10K (including FLEX 10KA and FLEX 10KE), FLEX 8000, FLEX 6000, and Excalibur[™] devices.
- Supports target systems using 5.0-V TTL, 3.3-V LVTTTL/LVCMOS, and single-ended I/O standards from 3.3 through 1.8 V.
- Provides a fast and low-cost method for in-system programming
- Supported by the Altera[®] Quartus[®] II development software
- Interfaces with a standard 25-pin parallel port on PCs
- Uses a 10-pin circuit board connector
- Supports SignalTap[®] II logic analysis in the Quartus II software

Functional Description

The ByteBlasterMV parallel port download cable (ordering code: PL-BYTEBLASTERMV) interfaces to a standard PC parallel port (also known as an LPT port). This cable drives configuration data from the PC to Stratix, Stratix GX, Stratix II, Cyclone, Cyclone II, APEX II, APEX 20K (including APEX 20K, APEX 20KE, and APEX 20KC), ACEX 1K, Mercury, Excalibur, FLEX 10K (including FLEX 10KA and FLEX 10KE), FLEX 8000, and FLEX 6000 devices, as well as programming data to MAX II, MAX 9000, MAX 7000S, MAX 7000AE, MAX 7000B, MAX 3000A devices, and EPC configuration devices. Because design changes are downloaded directly to the device, prototyping is easy and multiple design iterations can be accomplished in quick succession. See [Figure 2-1](#).

Download Modes

The ByteBlasterMV cable provides two download modes:

- Passive serial mode (PS)—In Passive Serial mode, the Quartus II Programmer can configure all Altera devices supported by the Quartus II software except MAX 3000 and MAX 7000 devices, and all programming options disappear from the Programmer window.

- JTAG mode—Industry-standard Joint Test Action Group (JTAG) interface. In JTAG mode, the Quartus II Programmer can program or configure all Altera devices supported by the Quartus II software, except FLEX 6000 devices.

In JTAG mode, you add specific devices and configuration devices to the device chain, in addition to POFs and SOFs, and you have several programming options for each configuration device in the chain. You can also verify EPC configuration device contents against its programming file data, check that a device is blank, examine a programmed device and save its data to file, or use its data to program or verify another configuration device. You can perform these functions for EPCS configuration devices using Active Serial mode.

ByteBlasterMV Connections

The ByteBlasterMV cable has a 25-pin male header that connects to the PC parallel port, and a 10-pin female plug that connects to the circuit board. Data is downloaded from the PC's parallel port through the ByteBlasterMV cable to the circuit board via the connections discussed in this section.



The ByteBlasterMV VCC pin must be connected to a specific voltage for the device being programmed (Table 2–1). Connect pull-up resistors to the same power supply as the ByteBlasterMV VCC.

| Family | ByteBlasterMV VCC Voltage Required |
|---|------------------------------------|
| MAX 7000S | 5.0 V |
| MAX 7000AE, MAX 3000A, MAX II | 3.3 V |
| MAX 7000B | 2.5 V |
| Stratix II, Stratix GX, Stratix | As specified by V _{CCSEL} |
| Cyclone II, Cyclone, APEX II, APEX 20K, Mercury | As specified by V _{CCIO} |
| FLEX 10K, FLEX 8000, FLEX 6000 | 5.0 V |
| FLEX 10KE | 2.5 V |
| FLEX 10KA, FLEX 6000A | 3.3 V |
| EPC2 | 5.0 V or 3.3 V |
| EPC4, EPC8, EPC16 | 3.3 V |

ByteBlasterMV Header & Plug Connections

The 25-pin male header connects to a parallel port with a standard parallel cable. [Table 2–2](#) identifies the pins and the download modes.

| Pin | PS Mode Signal | JTAG Mode Signal |
|----------|----------------|------------------|
| 2 | DCLK | TCK |
| 3 | nCONFIG | TMS |
| 4 | – | – |
| 5 | – | – |
| 8 | DATA0 | TDI |
| 11 | CONF_DONE | TDO |
| 13 | nSTATUS | – |
| 15 | nVCC Detect | nVCC detect |
| 18 to 25 | GND | GND |

The 10-pin female plug connects to a 10-pin male header on the circuit board containing the target device(s). [Figure 2–1](#) shows the dimensions of the female plug.

Figure 2–1. ByteBlasterMV 10-Pin Female Plug Dimensions

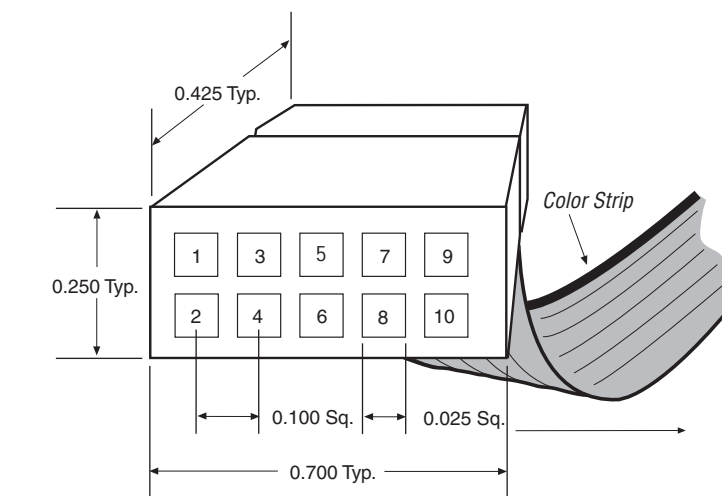



Table 2–3 identifies the 10-pin female plug’s pin names for the corresponding download mode.

| Pin | PS Mode | | JTAG Mode | |
|-----|-----------|-----------------------|-----------|----------------------------|
| | Signal | Description | Signal | Description |
| 1 | DCLK | Clock signal | TCK | Clock signal |
| 2 | GND | Signal ground | GND | Signal ground |
| 3 | CONF_DONE | Configuration Done | TDO | Data from device |
| 4 | VCC | Power supply | VCC | Power supply |
| 5 | nCONFIG | Configuration control | TMS | JTAG state machine control |
| 6 | – | No connect | – | No connect |
| 7 | nSTATUS | Configuration status | – | No connect |
| 8 | – | No connect | – | No connect |
| 9 | DATA0 | Data to device | TDI | Data to device |
| 10 | GND | Signal ground | GND | Signal ground |

 The circuit board must supply V_{CC} and ground to the ByteBlasterMV cable.

Circuit Board Header Connection

The ByteBlasterMV 10-pin female plug connects to a 10-pin male header on the circuit board. The 10-pin male header has two rows of five pins, which are connected to the device’s programming or configuration pins. The ByteBlasterMV cable receives power and downloads data via the male header. Figure 2–2 shows the dimensions of a typical 10-pin male header.

Figure 2–2. 10-Pin Male Header Dimensions

Dimensions are shown in inches

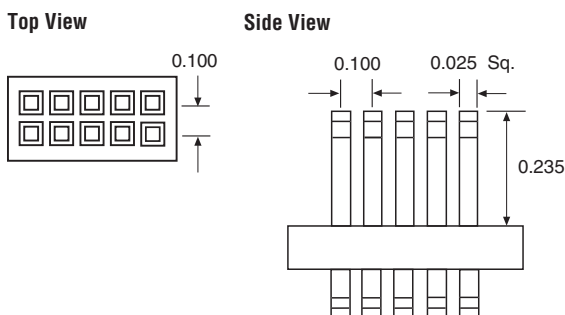

Operating Conditions

Tables 2–4 through 2–6 summarize the absolute maximum ratings, recommended operating conditions, and DC operating conditions for the ByteBlasterMV cable.

Table 2–4. ByteBlasterMV Cable Absolute Maximum Ratings

| Symbol | Parameter | Conditions | Min. | Max. | Unit |
|----------|----------------|------------------------|-------|------|------|
| V_{CC} | Supply voltage | With respect to ground | –0.5 | 7.0 | V |
| I_I | Input current | | –10.0 | 10.0 | mA |
| I_O | Output current | | –20.0 | 20.0 | mA |

Table 2–5. ByteBlasterMV Cable Recommended Operating Conditions

| Symbol | Parameter | Conditions | Min. | Max. | Unit |
|----------|---------------------------------|------------|-------|-------|------|
| V_{CC} | Supply voltage, 5.0-V operation | | 4.5 | 5.5 | V |
| | Supply voltage, 3.3-V operation | | 3.0 | 3.6 | V |
| | Supply voltage, 2.5-V operation | | 2.375 | 2.625 | V |

Table 2–6. ByteBlasterMV Cable DC Operating Conditions

| Symbol | Parameter | Conditions | Min. | Max. | Unit |
|-----------------|---------------------------------|---|-------|-------|------|
| V _{IH} | High-level input voltage | V _{CC} = 5.5 V | 2.32 | | V |
| | | V _{CC} = 3.6 V | 1.53 | | V |
| | | V _{CC} = 2.625 V | 1.11 | | V |
| | | V _{CC} = 1.89 V | 0.80 | | V |
| V _{IL} | Low-level input voltage | V _{CC} = 4.5 V | | 1.36 | V |
| | | V _{CC} = 3.0 V | | 0.89 | V |
| | | V _{CC} = 2.375 V | | 0.71 | V |
| | | V _{CC} = 1.71 V | | 0.51 | V |
| V _{OH} | 5.0-V high-level output voltage | V _{CC} = 4.5 V, I _{OH} = 8 mA | 4.4 | | V |
| | 3.3-V high-level output voltage | V _{CC} = 3.0 V, I _{OH} = 4 mA | 2.9 | | V |
| | 2.5-V high-level output voltage | V _{CC} = 2.375 V, I _{OH} = 2 mA | 2.275 | | V |
| | 1.8-V high-level output voltage | V _{CC} = 1.71 V, I _{OH} = 2 mA | 1.61 | | V |
| V _{OL} | 5.0-V low-level output voltage | V _{CC} = 5.5 V, I _{OL} = 8 mA | | 0.125 | V |
| | 3.3-V low-level output voltage | V _{CC} = 3.6 V, I _{OL} = 4 mA | | 0.125 | V |
| | 2.5-V low-level output voltage | TTL load. V _{CC} = 2.625 V, I _{OL} = 2 mA | | 0.125 | |
| I _{CC} | Operating current (no load) | | | 50 | mA |

Software Instructions

The Altera Quartus II design software package provides the programmer function required to configure or program devices using the ByteBlasterMV download cable.

To configure or program one or more devices with the ByteBlasterMV cable and the Quartus II Programmer, perform the following steps.



For a detailed explanation of the programming process, see the Programming module of the Quartus II tutorial. See also the “Overview: Working with Chain Description Files” and “Overview: Converting Programming Files” topics in Quartus II Help.

1. Compile a project. The Quartus II Compiler generates a programming file, such as a SOF, a POF, a Jam File (**.jam**), or a Jam Byte Code File (**.jbc**), depending on the target device.

2. Attach the ByteBlasterMV cable to a parallel port on the PC running the Quartus II software and insert the 10-pin female plug into the prototype system containing the target device. The board must supply power to the ByteBlasterMV cable.



A driver must be installed before using the ByteBlasterMV cable with many common operating systems. See [“Installation on a Windows PC” on page 1–1](#) for more information.

3. Open the Quartus II programmer by selecting **Programmer** (Tools menu). Choose **Setup** in the Programming Hardware section. Specify the ByteBlasterMV cable and the appropriate LPT port.



For more information on changing the hardware setup, see [“Installation on a Windows PC” on page 1–1](#), [“Installation on a Linux Workstation” on page 1–7](#), or [“Changing the Hardware Setup”](#) in the Quartus II Help.

4. Select either AS (active serial), PS (passive serial), In-Socket Programming, or JTAG programming mode, and then add the files and/or devices you want to program or configure using the **add file** or **add device** buttons to create a chain description file (.cdf).
5. Click **Start** in the Quartus II Programmer to program or configure the device(s). The ByteBlasterMV cable downloads the data from the **.pof** and/or **.sof** file(s) into the device(s).

Conclusion

Downloading configuration and programming data directly to the device via the ByteBlasterMV cable allows you to verify multiple design iterations in quick succession, thereby speeding the design cycle.

References

For more information on configuration and in-system programmability (ISP), see the following sources:

- *The Altera Configuration Handbook*
- *AN 95: In-System Programmability in MAX Devices*
- Search for the following terms in Quartus II Help:
 - ByteBlasterMV
 - Programming a Single Device or Multiple Devices in JTAG or Passive Serial Chains with the MasterBlaster or ByteBlasterMV
 - Configuration Scheme Description
 - Programmer Introduction
 - Programming

